



CHROM-VANADIUM





Großer Werkzeugschrank

100-101

zweitürig, aus Stahlblech
Schubfächer auf Teleskopschienen laufend

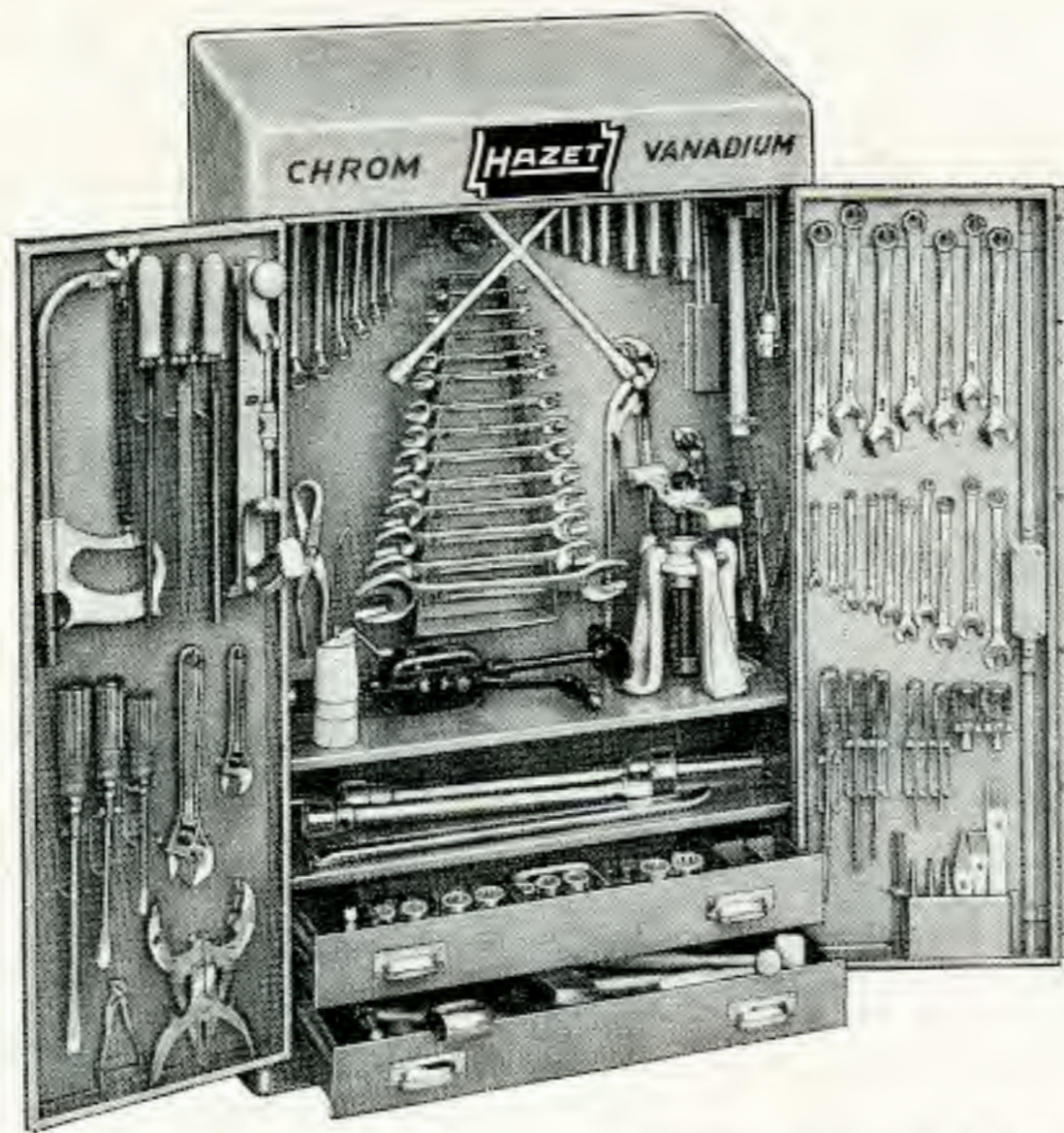

Schrankgröße: 1150 x 700 x 280 mm

Bestell-Nr.	Sortimente einschl. Werkzeugschrank	Gewicht kg	Verchromt
100	Metr. 140 teilig	78	1500.—
100 A	Amer. 135 teilig	76	1442.—
100 W	Engl. 124 teilig	74	1474.—
101	Metr. 143 teilig	87	1672.—
101 A	Amer. 138 teilig	85	1615.—
101 W	Engl. 127 teilig	83	1648.—
100 L	Schrank, leer	38	434.—

INHALTSÜBERSICHT

Nr.	Bezeichnung	Metr. 140 teilig HAZET 100	Amer. 135 teilig HAZET 100 A	Engl. 124 teilig HAZET 100 W
430	Steckschlüssel, massiv	8 x 9	—	—
		10 x 11	—	—
		12 x 13	—	—
		14 x 15	—	—
		16 x 17	—	—
		18 x 19	—	—
		20 x 22	—	—
		—	—	—
433	Drehstift	0619	—	—
433	Drehstift	2032	—	—
450	Gabelschlüssel	6 x 7	1/4 x 5/16	1/16 x 3/32
		8 x 9	5/16 x 3/8	3/32 x 1/8
		10 x 11	5/16 x 13/32	1/8 x 3/16
		12 x 13	3/8 x 7/16	3/16 x 1/4
		14 x 15	1/2 x 9/16	1/4 x 5/16
		16 x 17	9/16 x 5/8	5/16 x 3/8
		18 x 19	19/32 x 11/16	3/8 x 7/16
		20 x 22	5/8 x 3/4	7/16 x 1/2
		21 x 23	25/32 x 13/16	1/2 x 9/16
		24 x 26	7/8 x 15/16	9/16 x 5/8
		25 x 28	15/16 x 1	5/8 x 3/4
		27 x 32	1 x 1 1/8	3/4 x 7/8
36 x 41	1 1/16 x 1 1/4	7/8 x 1		
450 Rd	Gabelschlüsselsatz 8tlg.	6 - 22	1/4 - 1	1/16 - 1/2
600	Gabel-Ringschlüssel	6	1/4	1/8
		7	5/16	3/16
		8	3/8	1/4
		9	7/16	5/16
		10	1/2	3/8
		11	9/16	7/16
		12	5/8	1/2
		13	11/16	9/16
		14	3/4	5/8
		15	13/16	11/16
		16	7/8	3/4
		17	15/16	—
		18	1	—
		19	—	—
		20	—	—
		21	—	—
		22	—	—

Nr.	Bezeichnung	Metr. 140 teilig HAZET 100	Amer. 135 teilig HAZET 100 A	Engl. 124 teilig HAZET 100 W		
605	Gabel-Ringschlüssel, kurz	—	1/4 5/16	1/8 1 BA		
		—	3/8 7/16	0 BA 3/16		
		—	1/2 9/16	1/4 5/16		
		—	5/8 11/16	3/8 7/16		
		—	3/4	1/2		
630	Ringschlüssel, gekröpft	6 x 7	1/4 x 5/16	1/8 x 3/16		
		8 x 9	3/8 x 7/16	3/16 x 1/4		
		10 x 11	7/16 x 1/2	1/4 x 5/16		
		12 x 13	1/2 x 9/16	5/16 x 3/8		
		14 x 15	19/32 x 11/16	3/8 x 7/16		
		16 x 17	5/8 x 11/16	7/16 x 1/2		
		18 x 19	5/8 x 3/4	1/2 x 9/16		
		20 x 22	3/4 x 25/32	9/16 x 5/8		
		21 x 23	13/16 x 7/8	5/8 x 3/4		
		24 x 26	15/16 x 1	3/4 x 7/8		
		25 x 28	1 x 1 1/8	7/8 x 1		
		27 x 32	1 1/16 x 1 1/4	—		
		705 V	Kreuzschlüssel für PKW	17 x 19 x 20,64 x 22	5/8 x 3/4 x 13/16 x 7/8	5/16 x 3/8 x 7/16 x 1/2
761	Zündkerzenschl.	21 x 26	13/16 x 1	21 x 26		
769-1	Radmutterenschl.	24 x 27	15/16 x 1 1/16	5/8 x 3/4		
769-3	Radmutterenschl.	32 x 38	1 1/4 x 1 1/2	32 x 38		
769-4	Drehstange	18 ø	18 ø	18 ø		
900 Z	Zwölfkanteinsätze 1/2" □ Antrieb	10 12 13	3/8 7/16 1/2	3/16 1/4		
		14 15 16	9/16 19/32 5/8	5/16 3/8		
		17 18 19	11/16 3/4 25/32	7/16 1/2		
		20 21 22	13/16 7/8 15/16	9/16 5/8		
		23 24 26	31/32 1 1 1/16	11/16 3/4		
		27 28 30	1 1/8 1 3/16 1 1/4	—		
		32	—	—		
		2140	Hammer	300 g	—	—
		2141	Engl. Hammer	—	3/4 lbs.	3/4 lbs.

ALLE SORTIMENTE (100 - 100 A - 100 W) enthalten außerdem:

179V-6	Schraubenschlüssel 6", verstellbar	Betätigungswerkzeuge 1/2" □ Antrieb
179V-10	dito 10"	911 Schwinggriff 16 1/2"
650-20	Reifenheber 20", 2 Stück	914-15 Winkelgriff 15"
730-3	Flachmeißel 150 x 18	915 T-Griff 12"
730-6	dito 200 x 24	916 Umschaltknarre 12"
740-4	Kreuzmeißel 150 x 8	917 Verlängerung 5"
745-10	Durchschläger 120 x 2	918 Verlängerung 10"
745-12	dito 120 x 4	920 Universalgelenk
746-2	Körner 120 x 12	980-13 Schraubendreher-Einsatz 13 x 2
760-1	Universalzange 4 1/2"	1801-2 Seitenschneider 6 1/2"
760-3	dito 9 1/2"	1807-1 Vorschneider 6 1/2"
760-4	dito 15"	1841a-3 Long-Grip-Zange 8"
790-1	Kolbenringzange 50-100	Spezialzangen für Seegersicherungen
796	Bremsfederzange	1846a-2 innen, gerade
815-2	Schraubendreher 125 x 7	1846c-2 außen, gerade
815-4	dito 175 x 10	1850-3 Kombizange 7"
815-6	dito 250 x 13	1852 Figurenschere 8"
832-1	Elektrikerschraubendreher 60 x 2,5	1911 Handfaust
832-4	dito 100 x 4	1912 Handfaust
832-6	dito 140 x 5	1913 Handfaust
834-3	Schraubendreher für Vergaser, 25 x 8	1928 Löffeleisen
834-4	dito 25 x 10	1931 Biegeeisen
835-2	Kreuzschlitzschraubendreher für Phillips-Schrauben Nr. 5-10	1934 Karosseriefeile
835-3	dito für Schrauben Nr. 12-16	1935 Ausbeul- u. Schlichth.
		1938K Spann- u. Schlichth.
		1940 Schlicht- u. Treibh.
		1948 Gummi- u. Handh.
		1980 Metallsäge
		2120-10 Rundfeile 10"
		2122-10 Flachfeile 10"
		2123-10 Dreikantfeile 10"
		2125 Kontakfeilen, 2 Stück

INHALTSÜBERSICHT

	Metr. 143 teilig HAZET 101	Amer. 138 teilig HAZET 101 A	Engl. 127 teilig HAZET 101 W
--	----------------------------	------------------------------	------------------------------

Inhalt wie Sortiment 100, zusätzlich:

781-5	Radabzieher	2135	Handbohrmaschine
2160	Ölspritzkännchen		



Großer Werkzeugschrank
zweitürig, aus Stahlblech
Schubfächer auf Teleskopschienen laufend

102-103



Schrankgröße: 1150 x 700 x 280 mm

Bestell-Nr.	Sortimente einschl. Werkzeugschrank	Gewicht kg	Verchromt
102	Metr. 130 teilig	68	1298.—
103	Metr. 141 teilig	73	1412.—
100 L	Schrank, leer	38	434.—

INHALTSÜBERSICHT Metr. 130 teilig **HAZET 102**

Inhalt wie Sortiment 100,
ohne die nachstehend aufgeführten Ausbeulwerkzeuge:

1911	1912	1913	1928	1931
1934	1935	1938 K	1940	1948

INHALTSÜBERSICHT Metr. 141 teilig **HAZET 103**

Inhalt wie Sortiment 102,

zusätzlich:

1000 Z	Zwölfkant-Einsätze									
	$\frac{3}{4}$ " □ Antrieb									
		22	24	27	32	36	38	41	46	50

1015 Schiebegriff 20"

1017-8 Verlängerung 8 $\frac{1}{2}$ "



Kleiner Werkzeugschrank
zweitürig, aus Stahlblech

110

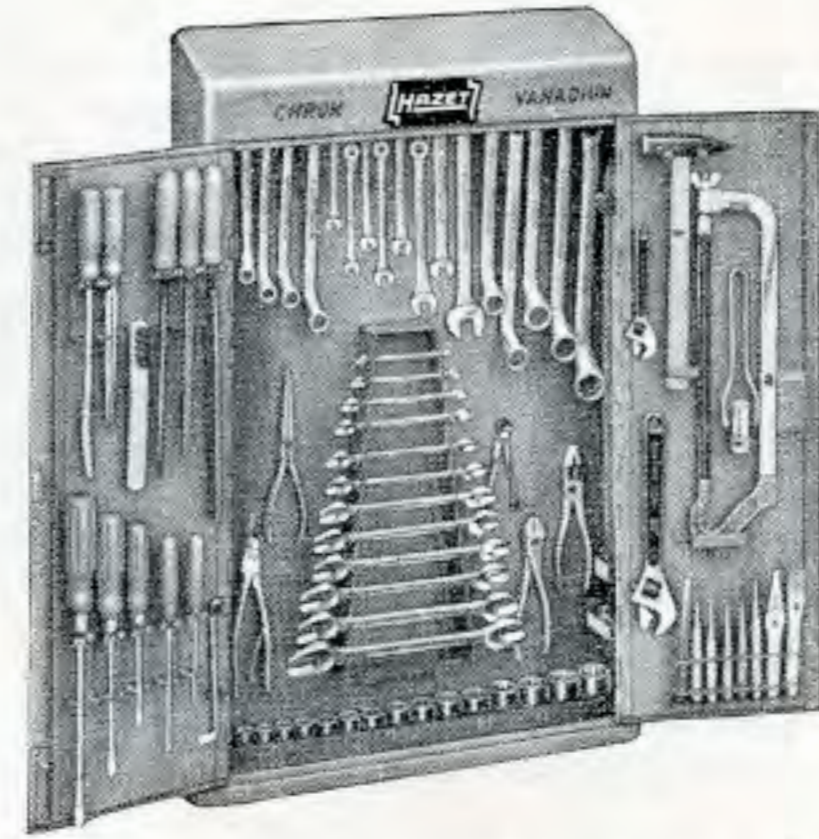

Schrankgröße: 860 x 550 x 125 mm

Bestell-Nr.	Sortimente einschl. Werkzeugschrank	Gewicht kg	Verchromt
110	Metr. 95 teilig	30	728.—
110 A	Amer. 92 teilig	28	718.—
110 W	Engl. 79 teilig	27	688.—
110 L	Schrank, leer	13	204.—

INHALTSÜBERSICHT

Nr.	Bezeichnung	Metr. 95 teilig HAZET 110	Amer. 92 teilig HAZET 110A	Engl. 79 teilig HAZET 110W		
450	Gabelschlüssel	6 x 7	$\frac{1}{4} \times \frac{5}{16}$	$\frac{1}{8} \times \frac{3}{16}$		
		8 x 9	$\frac{5}{16} \times \frac{13}{32}$	$\frac{3}{16} \times \frac{1}{4}$		
		10 x 11	$\frac{3}{8} \times \frac{7}{16}$	$\frac{1}{4} \times \frac{5}{16}$		
		12 x 13	$\frac{1}{2} \times \frac{9}{16}$	$\frac{5}{16} \times \frac{3}{8}$		
		14 x 15	$\frac{9}{16} \times \frac{5}{8}$	$\frac{3}{8} \times \frac{7}{16}$		
		16 x 17	$\frac{19}{32} \times \frac{11}{16}$	$\frac{7}{16} \times \frac{1}{2}$		
		18 x 19	$\frac{5}{8} \times \frac{3}{4}$	$\frac{1}{2} \times \frac{9}{16}$		
		20 x 22	$\frac{25}{32} \times \frac{13}{16}$	$\frac{9}{16} \times \frac{5}{8}$		
		21 x 23	$\frac{7}{8} \times \frac{15}{16}$	$\frac{5}{8} \times \frac{3}{4}$		
		24 x 26	$\frac{15}{16} \times 1$	$\frac{3}{4} \times \frac{7}{8}$		
		25 x 28	$1 \times 1\frac{1}{8}$			
		27 x 32	$1\frac{1}{16} \times 1\frac{1}{4}$			
		600	Gabel-Ringschlüssel	10 11	$\frac{3}{8} \quad \frac{7}{16}$	$\frac{1}{8} \quad \frac{3}{16}$
				12 13	$\frac{1}{2} \quad \frac{9}{16}$	$\frac{1}{4} \quad \frac{5}{16}$
14 17	$\frac{5}{8} \quad \frac{11}{16}$			$\frac{3}{8} \quad \frac{7}{16}$		
19 22	$\frac{3}{4} \quad \frac{7}{8}$			$\frac{1}{2}$		
630	Ringschlüssel, gekröpft	6 x 7	$\frac{1}{4} \times \frac{5}{16}$	$\frac{1}{8} \times \frac{3}{16}$		
		8 x 9	$\frac{3}{8} \times \frac{7}{16}$	$\frac{3}{16} \times \frac{1}{4}$		
		10 x 11	$\frac{7}{16} \times \frac{1}{2}$	$\frac{1}{4} \times \frac{5}{16}$		
		12 x 13	$\frac{1}{2} \times \frac{9}{16}$	$\frac{5}{16} \times \frac{3}{8}$		
		14 x 15	$\frac{19}{32} \times \frac{11}{16}$	$\frac{3}{8} \times \frac{7}{16}$		
		16 x 17	$\frac{5}{8} \times \frac{11}{16}$	$\frac{7}{16} \times \frac{1}{2}$		
		18 x 19	$\frac{5}{8} \times \frac{3}{4}$	$\frac{1}{2} \times \frac{9}{16}$		
		20 x 22	$\frac{3}{4} \times \frac{25}{32}$	$\frac{9}{16} \times \frac{5}{8}$		
		21 x 23	$\frac{13}{16} \times \frac{7}{8}$	$\frac{5}{8} \times \frac{3}{4}$		
		24 x 26	$\frac{15}{16} \times 1$	$\frac{3}{4} \times \frac{7}{8}$		
		25 x 28	$1 \times 1\frac{1}{8}$			
		27 x 32	$1\frac{1}{16} \times 1\frac{1}{4}$			
		761	Zündkerzenschlüssel	21 x 26	$\frac{13}{16} \times 1$	21 x 26
		900 Z	Zwölfkanteinsätze $\frac{1}{2}$ " □ Antrieb	10 11 12	$\frac{3}{8} \quad \frac{7}{16} \quad \frac{1}{2}$	$\frac{3}{16} \quad \frac{1}{4} \quad \frac{5}{16}$
13 14 15	$\frac{9}{16} \quad \frac{19}{32} \quad \frac{5}{8}$			$\frac{3}{8} \quad \frac{7}{16} \quad \frac{1}{2}$		
16 17 18	$\frac{11}{16} \quad \frac{3}{4} \quad \frac{25}{32}$			$\frac{9}{16} \quad \frac{5}{8} \quad \frac{11}{16}$		
19 20 21	$\frac{13}{16} \quad \frac{7}{8} \quad \frac{15}{16}$			$\frac{3}{4}$		
22 23 24	$\frac{31}{32} \quad 1 \quad 1\frac{1}{16}$					
25 26 27	$1\frac{1}{8} \quad 1\frac{3}{16} \quad 1\frac{1}{4}$					
28 30 32						
2140	Hammer	300 g	—	—		
2141	Engl. Hammer	—	$\frac{3}{4}$ lbs.	$\frac{3}{4}$ lbs.		

ALLE SORTIMENTE (110 - 110A - 110W) enthalten außerdem:

179-6	Schraubenschlüssel 6", verstellbar	745-12	dito 120 x 4
179-10	dito 10"	745-19	dito 150 x 4
650-20	Reifenheber 20", 2 Stück	746-2	Körner 120 x 12
730-3	Flachmeißel 150 x 18	760-1	Universalzange 4 $\frac{1}{2}$ "
740-3	Kreuzmeißel 150 x 8	760-3	dito 9 $\frac{1}{2}$ "
745-10	Durchschläger 120 x 2	811-3	Werkstattschraubendreher 100 x 6
745-11	dito 120 x 3	811-9	dito 150 x 8
		811-13	dito 200 x 10

Fortsetzung nächste Seite

813-2	Elektrikerschraubendreher 80 x 3	980-13	Schraubendreher-Einsatz 13 x 2
813-5	dito 140 x 5	1801-2	Seitenschneider 6 1/2"
818-3	Winkelschraubendreher 150 x 8	1841a-3	Long-Grip-Zange 8"
821-1	Dreikantschaber 150	1848	Batterie- und Mutternzange
824-3	Löffelschaber 200	1850-3	Kombizange 7"
	Betätigungswerkzeuge 1/2" □ Antrieb	1852	Figureschere 8"
915	T-Griff 12"	1981	Metallsäge
916	Umschaltknarre 12"	2120-8	Rundfeile 8"
917	Verlängerung 5"	2122-10	Flachfeile 10"
918	Verlängerung 10"	2123-8	Dreikantfeile 8"
920	Universalgelenk	2125	Kontaktfeilen, 3 Stück
		2131	Zündkerzenbürste

HAZET
110 AWM

Kleiner Werkzeugschrank
Metrische, amerikanische und englische Maße kombiniert

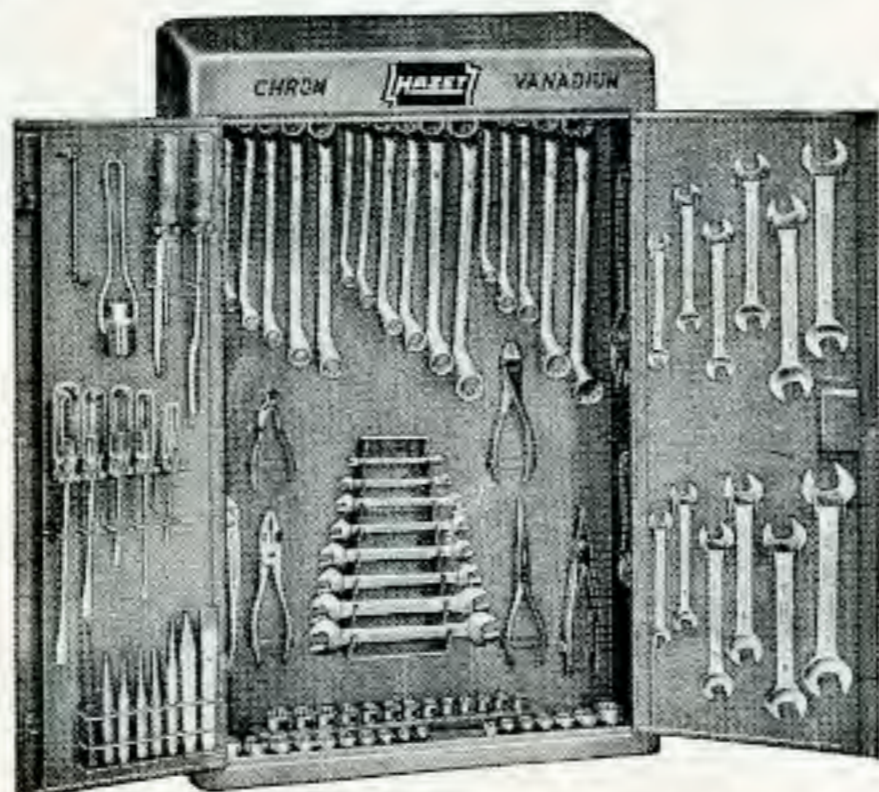

Schrankgröße: 860 x 550 x 125 mm

Bestell-Nr.	Sortiment einschl. Werkzeugschrank	Gewicht kg	Verchromt
110 AWM	Metr., amerik. u. engl. 100 teilig	27	718.—
110 L	Schrank, leer	13	204.—

INHALTSÜBERSICHT

179-6	Schraubenschlüssel 6", verstellbar	760-1	Universalzange 4 1/2"
179-10	dito 10"	760-3	dito 9 1/2"
450	Gabelschlüssel 6x7 8x9 10x11 12x13 14x15 16x17 18x19 20x22	761	Zündkerzenschlüssel
450A	Gabelschlüssel 3/8 x 7/16 1/2 x 9/16 19/32 x 11/16 5/8 x 3/4 25/32 x 7/8 15/16 x 1	818-3	Winkelschraubendreher 150 x 8
450W	Gabelschlüssel 1/8 x 3/16 3/16 x 1/4 1/4 x 5/16 5/16 x 3/8 3/8 x 7/16 7/16 x 1/2	821-1	Dreikantschaber 150
630	Ringschlüssel, gekröpft 6x7 8x9 10x11 12x13 14x15 16x17 18x19 20x22	824-3	Löffelschaber 200
630A	Ringschlüssel, gekröpft 3/8 x 7/16 1/2 x 9/16 5/8 x 11/16 3/4 x 25/32 13/16 x 7/8 15/16 x 1	830-3	Werkstattschraubendreher 100 x 6
630W	Ringschlüssel, gekröpft 1/8 x 3/16 1/4 x 5/16 5/16 x 3/8 7/16 x 1/2	830-9	dito 150 x 8
730-3	Flachmeißel 150 x 18	830-13	dito 200 x 10
740-3	Kreuzmeißel 150 x 8	832-2	Elektrikerschraubendreher 80 x 3
745-10	Durchschläger 120 x 2	832-6	dito 140 x 5
745-11	dito 120 x 3	900Z	Zwölfkant-Einsätze 1/2" □ Antrieb 10 11 12 13 14 15 16 17 18 19 20 21 22
745-12	dito 120 x 4	900AZ	dito 3/8 7/16 1/2 9/16 5/8 11/16 3/4 25/32 13/16 7/8
745-19	dito 150 x 4	900WZ	dito 3/16 1/4 5/16 3/8 7/16 1/2
746-2	Körner 120 x 12		Betätigungswerkzeuge 1/2" □ Antrieb
		915	T-Griff 12"
		916	Umschaltknarre 12"
		917	Verlängerung 5"
		918	Verlängerung 10"
		920	Universalgelenk
		980-13	Schraubendreher-Einsatz 13 x 2
		1801-2	Seitenschneider 6 1/2"
		1841a-3	Long-Grip-Zange 8"
		1848	Batterie- und Mutternzange
		1850-3	Kombizange 7"
		1852	Figureschere 8"
		2125	Kontaktfeile



Werkbank mit Aufsatzschrank

Werkbank mit 2 Untersätzen auf verstellbaren Füßen
Aufsatzschrank mit Aluminiumrollladen
Sämtliche Werkzeugplätze farblich schabloniert

130



Aufsatzschrank:
1800 mm lang
160 mm tief
850 mm hoch

Werkbank:
2000 mm lang
800 mm tief
860 mm hoch

Bestell-Nr.	Sortimente	Gewicht kg	Verchromt
130	Werkbank und Aufsatzschrank, mit 107 Werkzeugen, metr.	254	2924.—
130 MS	Aufsatzschrank, ohne Werkbank, mit 107 Werkzeugen, metr.	74	1831.—
130-1	Werkbank und Aufsatzschrank, mit 122 Werkzeugen, metr.	266	3230.—
130-1 MS	Aufsatzschrank, ohne Werkbank, mit 122 Werkzeugen, metr.	86	2137.—
130 L	Werkbank, leer	180	1093.—
130 SL	Aufsatzschrank, leer	44	1135.—

INHALTSÜBERSICHT

Sortiment HAZET 130 bzw. 130 MS

179V-6	Schraubenschlüssel 6", verstellbar	815-4	Schraubendr. 175 x 10
179V-10	dito 10"	815-6	dito 250 x 13
430	Steckschlüssel, massiv 8x9 10x11 12x13 14x15 16x17 18x19 20x22	832-1	Elektrikerschraubendreher 60 x 2,5
433	Drehstifte, 0619, 2032	832-4	dito 100 x 4
450	Gabelschlüssel 6x7 8x9 10x11 12x13 14x15 16x17 18x19 20x22 21x23 24x26 25x28 27x32	832-6	dito 140 x 5
600	Gabel-Ringschlüssel 10 11 12 13 14 17 19 22	834-3	Schraubendreher für Vergaser 25 x 8
630	Ringschlüssel, gekröpft 6x7 8x9 10x11 12x13 14x15 16x17 18x19 20x22 21x23 24x26 25x28 27x32	834-4	dito 25 x 10
650-20	Reifenheber 20", 2 Stück	835-2	Kreuzschlitzschraubendreher für Phillips-Schrauben Nr. 5-10
705V	Kreuzschlüssel für PKW 17x19x20,64x22	835-3	dito für Phillips-Schrauben Nr. 12-16
730-3	Flachmeißel 150 x 18	900Z	Zwölfkant-Einsätze 1/2" □ Antrieb 12 13 14 15 16 17 18 19 20 21 22 23 24 26 27 28 30 32
730-6	dito 200 x 24		Betätigungswerkzeuge 1/2" □ Antrieb
740-3	Kreuzmeißel 150 x 8	911	Schwunggriff 16 1/2"
745-10	Durchschläger 120 x 2	914-15	Winkelgriff 15"
745-12	dito 120 x 4	915	T-Griff 12"
746-2	Körner 120 x 12	916	Umschaltknarre 12"
760-1	Universalzange 4 1/2"	917	Verlängerung 5"
760-3	dito 9 1/2"	918	Verlängerung 10"
760-4	dito 15"	920	Kardangelen
761	Zündkerzenschlüssel 21 x 26	980-13	Schraubendreher-Einsatz 13 x 2
790-1	Kolbenringzange 50-100	1801-2	Seitenschneider 6 1/2"
796	Bremsfederzange	1807-1	Vorschneider 6 1/2"
815-2	Schraubendreher 125 x 7	1850-3	Kombizange 7"
		1852	Figureschere 8"
		1950-4	Plastic-Hammer 105 x 35
		1980	Metallsäge
		2120-10	Rundfeile 10"
		2122-10	Flachfeile 10"
		2123-10	Dreikantfeile 10"
		2125	Kontaktfeilen, 3 Stück
		2140-3	Hammer 300 g



Werkbank mit Aufsatzschrank

130

INHALTSÜBERSICHT

Sortiment HAZET 130-1 bzw. 130-1 MS

Inhalt wie Sortiment 130, zusätzlich:

769-1	Radmutternschlüssel 24 x 27	1935	Ausbeul- und Schlichthammer
769-3	dito 32 x 38	1938 K	Spann- und Schlichthammer
769-4	Drehstange 18 ø		
1911	Handfaust	1940	Schlicht- und Treibhammer
1912	Handfaust		
1913	Handfaust	1948	Gummi- und Handhammer
1928	Löffeleisen		
1931	Biegeeisen	2135	Handbohrmaschine
1934	Karosseriefeile	2160	Ölspritzkännchen

Sortimente auch in amerikanischen oder englischen Zollmaßen lieferbar.



Werkzeugkoffer „Juwel“

Schubfächer auf Teleskopschienen laufend

150-152

Durch Überfalldeckel verschließbar
Seitliche Tragegriffe



Koffergröße: 600 x 280 x 300 mm
mit 3 Schubfächern



Koffergröße: 665 x 310 x 360 mm
mit 4 Schubfächern

152 L

Bestell-Nr.	Bezeichnung	Gewicht kg	Preis
150 L	Werkzeugkoffer „Juwel“, leer mit 3 Schubfächern	19	284.—
152 L	Werkzeugkoffer „Juwel“, leer mit 4 Schubfächern	25	318.—

Spezial-Werkzeugsortimente, komplett mit Werkzeugkoffer

Bestell-Nr.	Zusammensetzung	Gewicht kg	Verchromt
Motorenschlosser-Sortiment			
150	Metr. 135 teilig, 3 Schubfächer	46	1200.—
152	Metr. 135 teilig, 4 Schubfächer	52	1234.—
150 A	Amer. 132 teilig, 3 Schubfächer	44	1186.—
152 A	Amer. 132 teilig, 4 Schubfächer	50	1220.—
Baumaschinen-Sortiment			
150 - 1	Metr. 107 teilig, 3 Schubfächer	52	1106.—
152 - 1	Metr. 107 teilig, 4 Schubfächer	58	1140.—
Baumaschinen-Sortiment für amerik. Baumaschinen, z. B. Caterpillar usw.			
150 - 2 A	Amer. 106 teilig, 3 Schubfächer	53	1172.—
152 - 2 A	Amer. 106 teilig, 4 Schubfächer	59	1206.—

Werkzeugkoffer „Juwel“

Motorenschlosser-Sortiment

Bestell-Nr. 150	135 teilig
Bestell-Nr. 152	135 teilig
Bestell-Nr. 150 A	132 teilig
Bestell-Nr. 152 A	132 teilig

INHALTSÜBERSICHT

Nr.	Bezeichnung	Metr. Sort. 135 teilig	Amer. Sort. 132 teilig
450	Gabelschlüssel	6 x 7	1/4 x 5/16
		8 x 9	5/16 x 13/32
		10 x 11	3/8 x 7/16
		12 x 13	1/2 x 9/16
		14 x 15	9/16 x 5/8
		16 x 17	19/32 x 11/16
		18 x 19	5/8 x 3/4
		20 x 22	25/32 x 13/16
		21 x 23	7/8 x 15/16
		24 x 26	15/16 x 1
		25 x 28	1 x 1 1/8
		27 x 32	1 1/16 x 1 1/4
		600	Gabel-Ringschlüssel
11	7/16		
12	1/2		
13	9/16		
14	5/8		
17	3/4		
19	7/8		
615	Starter- und Blockschlüssel	11 x 13	7/16 x 1/2
		14 x 17	9/16 x 5/8
		19 x 22	5/8 x 3/4
			3/4 x 7/8
630	Ringschlüssel, gekröpft	6 x 7	3/8 x 7/16
		8 x 9	1/2 x 9/16
		10 x 11	5/8 x 11/16
		12 x 13	3/4 x 25/32
		14 x 15	13/16 x 7/8
		16 x 17	15/16 x 1
		18 x 19	
		20 x 22	
635	Ringschlüssel, gekröpft, kurze Form	9 x 10	3/8 x 7/16
		12 x 14	1/2 x 9/16
		17 x 19	5/8 x 11/16
		5/8 x 3/4	
761	Zündkerzenschlüssel	21 x 26	13/16 x 1
850	Sechskant-Einsätze 1/4" □ Antrieb	4 4,5 5	3/16 7/32 1/4
		5,5 6 7	9/32 5/16 11/32
		8 9 10 11	3/8 7/16
900 Z	Zwölfkant-Einsätze 1/2" □ Antrieb	12 13 14	3/8 7/16 1/2
		15 16 17	9/16 19/32 5/8
		18 19 20	11/16 3/4 25/32
		21 22 23	13/16 7/8 15/16
		24 26 27	31/32 1 1 1/16
		28 30 32	1 1/8 1 3/16 1 1/4
1000 Z	Zwölfkant-Einsätze 3/4" □ Antrieb	22 24 27	7/8 15/16 1
		30 32 36	1 1/16 1 1/8 1 3/8
		38 41 46 50	1 1/4 1 5/16 1 3/8
			1 7/16
2140	Hammer	500 g	—
2141	Hammer	—	1 lbs.
2147	Fühlerlehre	metr.	—
2147 A	Fühlerlehre	—	SAE

ALLE SORTIMENTE (150/152 - 150/152 A) enthalten außerdem:

179-6	Schraubenschlüssel 6", verstellbar	815-6	Schraubendreher 250 x 13
179-10	dito 10"	830-1	dito 75 x 5
730-6	Flachmeißel 200 x 24	830-3	dito 100 x 6
731-2	dito 130 x 11	830-6	dito 125 x 7
731-5	dito 150 x 15	830-9	dito 150 x 8
740-3	Kreuzmeißel 150 x 8	833-1	Schraubendreher 60 x 2,5
741-1	dito 130 x 4	834-3	Schraubendreher für Vergaser, 25 x 8
745-11	Durchschläger 120 x 3	835-1	Kreuzschlitzschraubendreher für Phillips-Schrauben Nr. 2-4
745-19	dito 150 x 4		
746-1	Körner 120 x 10	835-2	dito 5-10
746-2	dito 120 x 12	835-3	dito 12-16
760-1	Universalzange 4 1/2"	835-4	dito 18 und größer
760-3	dito 9 1/2"	835-02	dito 5-10
760-4	dito 15"		
815-5	Schraubendreher 200 x 11		

Fortsetzung nächste Seite

INHALTSÜBERSICHT (Fortsetzung)

Betätigungswerkzeuge 1/4" □ Antrieb		Betätigungswerkzeuge 3/4" □ Antrieb	
863	Umschaltknarre 4 1/2"	1014	Stecker 20"
864	Gelenkgriff 6"	1015	Schiebegriff 20"
865	Schiebegriff 5"	1016	Knarrenkopf
866	Vierkantknebel 5"	1017-8	Verlängerung 8 1/2"
867	Verlängerung 2"	1018	Verlängerung 17"
868	Verlängerung 6"	1020	Gelenkstück
869	Kardangelen		
Betätigungswerkzeuge 1/2" □ Antrieb		1801-2	Seitenschneider 6 1/2"
911	Schwunggriff 16 1/2"	1807-1	Vorschneider 6 1/2"
914-15	Winkelgriff 15"	1841a-3	Long-Grip-Zange 8"
915	T-Griff 12"	1850-3	Kombizange 7"
916	Umschaltknarre 12"	1852	Figurenschere 8"
917	Verlängerung 5"	1950-4	Plastic-Hammer 105 x 35
918	Verlängerung 10"	1980	Metallsäge
920	Universalgelenk	2125	Kontaktfeilen, 3 Stück
980-13	Schraubendreher- Einsatz 13 x 2	2130	Drahtbürste
		2131	Zündkerzenbürste

Werkzeugkoffer „Juwel“
Baumaschinen-Sortiment Metr. Maße

Bestell-Nr. 150-1 107 teilig
Bestell-Nr. 152-1 107 teilig

Dieses Sortiment kann auch im Werkzeugwagen HAZET „Assistent“ unter der Bestell-Nr. HAZET 162-15 geliefert werden (siehe Seite 7 u. 8)

INHALTSÜBERSICHT

320	Ventil-Einstellschlüssel 14 x 14 17 x 17 je 2 Stück	900 Z	Zwölfkant-Einsätze 1/2" □ Antrieb 10 11 12 14 16 17 19 22 24 27
450	Gabelschlüssel 6x7 8x9 10x11 12x13 14x15 16x17 18x19 20x22 21x23 24x26 27x29 30x32	900AZ	Zwölfkant-Einsätze 1/2" □ Antrieb 1 1/16 1/8 1 3/16
450A	Gabelschlüssel 1/4 x 5/16 5/16 x 13/32 3/8 x 7/16 1/2 x 9/16 9/16 x 5/8 19/32 x 11/16 5/8 x 3/4 25/32 x 13/16 7/8 x 15/16 15/16 x 1 1 x 1 1/8 1 1/16 x 1 1/4		Betätigungswerkzeuge 1/2" □ Antrieb
600	Gabel-Ringschlüssel 8 9 10 11 12 14 17 19 21 22 24 27 30 32	911	Schwunggriff 16 1/2"
630	Ringschlüssel, gekröpft 10x11 12x13 14x17 19x22 21x23 24x27 30x32 36x41	914-18	Winkelgriff 18"
730-4	Flachmeißel 150 x 20	915	T-Griff 12"
730-6	dito 200 x 24	916	Umschaltknarre 12"
745-14	Durchschläger 120 x 6	917	Verlängerung 5"
745-16	dito 120 x 8	918	Verlängerung 10"
745-18	dito 120 x 10	920	Universalgelenk
746-2	Körner 120 x 12	1000	Sechskant-Einsätze 3/4" □ Antrieb 22 24 27 30 32 36 41 46 50 55 60
748-7	Splintentreiber 150 x 6	1000AZ	Zwölfkant-Einsatz 3/4" □ Antrieb 1 1/2
748-8	dito 150 x 8		Betätigungswerkzeuge 3/4" □ Antrieb
757-10	Universal-Gripzange 10"	1014	Stecker 20"
760-3	Universalzange 9 1/2"	1015	Schiebegriff 20"
760-4	dito 15"	1016	Knarrenkopf 6"
811-7	Werkstattschraub- dreher 150 x 7	1017-8	Verlängerung 8 1/2"
811-14	dito 250 x 10	1020	Gelenkstück 5"
		1801-2	Seitenschneider 6 1/2"
		1842	Splintenauszieh- zange 7"
			Spezialzangen für Seegersicherungen
		1846a-2	innen, gerade
		1846d-2	außen, abgewinkelt
		1850-2	Kombizange 6 1/2"
		2141-4	Engl. Hammer 2 lbs.
		2147	Fühlerlehre

Werkzeugkoffer „Juwel“

Baumaschinen-Sortiment Amerik. Maße

für amerik. Baumaschinen, z. B. Caterpillar usw.

Bestell-Nr. 150-2 A

106 teilig

Bestell-Nr. 152-2 A

106 teilig

INHALTSÜBERSICHT

320A	Ventileinstellschlüssel 1/2 x 9/16, 2 Stück	900AZ	Zwölfkant-Einsätze 1/2" □ Antrieb 9/16 5/8 11/16 3/4 13/16 7/8 15/16 1
450A	Gabelschlüssel 1/4 x 5/16 5/16 x 13/32 3/8 x 7/16 1/2 x 9/16 9/16 x 5/8 19/32 x 11/16 5/8 x 3/4 25/32 x 13/16 7/8 x 15/16 15/16 x 1 1 x 1 1/8 1 1/16 x 1 1/4		Betätigungswerkzeuge 1/2" □ Antrieb
600A	Gabel-Ringschlüssel 1/4 5/16 3/8 7/16 1/2 9/16 5/8 11/16 3/4 13/16 7/8 15/16 1 1 1/16 1 1/8 1 1/4 1 5/16 1 3/8	911	Schwunggriff 16 1/2"
625A	Ringschlüssel, flach gekröpft 3/8 x 7/16 1/2 x 9/16 5/8 x 11/16 3/4 x 7/8 25/32 x 13/16 15/16 x 1 1 x 1 1/8 1 1/16 x 1 1/4 1 1/4 x 1 3/8	914-18	Winkelgriff 18"
730-4	Flachmeißel 150 x 20	915	T-Griff 12"
730-6	Flachmeißel 200 x 24	916	Umschaltknarre 12"
746-2	Körner 120 x 12	918	Verlängerung 10"
748-5	Splintentreiber 150 x 4	920	Universalgelenk
748-8	dito 150 x 8	958 R I	Reduzier-Einsatz 1/2 x 3/8"
757-10	Universal-Gripzange 10"	1000AZ	Zwölfkant-Einsätze 3/4" □ Antrieb 7/8 15/16 1 1 1/16 1 1/8 1 1/4 1 5/16 1 1/2 1 5/8 1 11/16 1 3/4 1 7/8 2
760-3	Universalzange 9 1/2"		Betätigungswerkzeuge 3/4" □ Antrieb
760-4	dito 15"	1014	Stecker 20"
815-3	Schraubendreher 150 x 9	1015	Schiebegriff 20"
815-6	dito 250 x 13	1016	Knarrenkopf 6"
830-12	Schraubendreher 150 x 10	1017-8	Verlängerung 8 1/2"
836-5	dito 200 x 11	1020	Gelenkstück 5"
880AZ	Zwölfkant-Einsätze 3/8" □ Antrieb 7/16 1/2 9/16 5/8 3/4	1058R II	Reduziereinsatz 3/4 x 1/2"
	Betätigungswerkzeuge 3/8" □ Antrieb	1801-2	Seitenschneider 6 1/2"
8811	Schwungwinde 18"	1825-2	Langbeckzange 6 1/2"
8816	Umschaltknarre 8"	1842	Splintenauszieh- zange 7"
8820	Kardangelen		Spezialzangen für Seegersicherungen
8821-3	Verlängerung 3"	1846a-2	innen, gerade
8821-6	Verlängerung 6"	1846d-2	außen, abgewinkelt
		1850-2	Kombizange 6 1/2"
		2141-4	Engl. Hammer 2 lbs.
		2147A	Fühlerlehre
		2165-1	Hebeleisen 16"





Assistent

Werkzeug-, Material- u. Montagewagen

für den innerbetrieblichen rationellen Transport
in allen Branchen

DBP Nr. 949640 und Auslandspatente

161 mit einem Zwischenkasten

162 mit zwei Zwischenkästen



161 L



162



Maße: 930 x 650 x 330 mm

Bestell-Nr.	Bezeichnung	Gewicht kg	Preis
161 L	Werkzeugwagen, leer mit 1 Zwischenkasten	22	284.—
162 L	Werkzeugwagen, leer mit 2 Zwischenkästen	26	336.—

Spezial-Werkzeugsortimente, komplett mit Werkzeugwagen

Bestell-Nr.	Zusammensetzung	Gewicht kg	Verchromt
Motorenschlosser-Sortiment			
161	Metr. 100 teilig, 1 Zwischenkasten	33	774.—
161-1	Metr. 64 teilig, 1 Zwischenkasten	30	585.—
162	Metr. 100 teilig, 2 Zwischenkästen	37	826.—
162-1	Metr. 64 teilig, 2 Zwischenkästen	34	637.—
2500 A 1/71	Metr. 71 teilig für VW, 1 Zwischenkasten		siehe Seite 52
A 2/71	Metr. 71 teilig für VW, 2 Zwischenkästen		
2500 A 1/68	Metr. 68 teilig für VW, 1 Zwischenkasten		
A 2/68	Metr. 68 teilig für VW, 2 Zwischenkästen		

Landmaschinen-Sortiment

161-11	Metr. 74 teilig, 1 Zwischenkasten	43	823.—
162-11	Metr. 74 teilig, 2 Zwischenkästen	47	875.—

Industrie-Sortiment

162-14	Metr. 100 teilig, 2 Zwischenkästen	45	982.—
--------	------------------------------------	----	-------

Baumaschinen-Sortiment

162-15	Metr. 107 teilig, 2 Zwischenkästen	59	1159.—
--------	------------------------------------	----	--------

Motorenschlosser

Bestell-Nr. 161

Bestell-Nr. 162

Großes Sortiment

100 teilig

100 teilig

INHALTSÜBERSICHT

330	Kleingabelschlüssel 3,5 x 4 4 x 3,5 4,5 x 5 5 x 4,5 5,5 x 6 6 x 5,5 7 x 8 8 x 7 9 x 10 10 x 9 11 x 12 12 x 11	Betätigungswerkzeuge 1/4" □ Antrieb
		863 Umschaltknarre 4 1/2"
		864 Gelenkgriff 6"
		865 Schiebegriff 5"
		866 Vierkantknebel 5"
		867 Verlängerung 2"
		868 Verlängerung 6"
		869 Kardangelen
		900Z Zwölfkant-Einsätze 1/2" □ Antrieb
		10 12 13 14 15
		16 17 18 19 20
		21 22 23 24 26
		27 28 30 32
		Betätigungswerkzeuge 1/2" □ Antrieb
		911 Schwunggriff 16 1/2"
		915 T-Griff 12"
		916 Umschaltknarre 12"
		917 Verlängerung 5"
		918 Verlängerung 10"
		920 Universalgelenk
		980-13 Schraubendreher-Einsatz 13 x 2
		1801-2 Seitenschneider 6 1/2"
		1850-3 Kombizange 7"
		1950-4 Plastic-Hammer 105 x 35
		2125 Kontaktfeile
		2130 Drahtbürste
		2140-5 Hammer 500 g
		2147 Fühlerlehre
		2161 Ölkännchen
		2161 Kännchen für Caramba
		2163 Fettbüchse
450	Gabelschlüssel 6x7 8x9 10x11 12x13 14x15 16x17 18x19 20x22 21x23 24x26 25x28 27x32	
625	Ringschlüssel, flach gekröpft 6x7 8x9 10x11 12x13 14x15 16x17 18x19 20x22	
730-3	Flachmeißel 150 x 18	
740-3	Kreuzmeißel 150 x 8	
745-10	Durchschläger 120 x 2	
746-2	Körner 120 x 12	
748-4	Splintentreiber 150 x 3	
748-5	dito 150 x 4	
748-6	dito 150 x 5	
760-1	Universalzange 4 1/2"	
760-3	dito 9 1/2"	
761	Zündkerzenschlüssel 21 x 26	
811-6	Werkstattschraubendreher 125x7	
811-13	dito 200 x 10	
813-3	Elektrikerschraubendreher 100 x 3,5	
833-1	Schraubendreher 60 x 2,5	
834-3	Schraubendreher für Vergaser, 25 x 8	
850	Sechskant-Einsätze 1/4" □ Antrieb 4 4,5 5 5,5 6 7 8 9 10 11	

Motorenschlosser

Bestell-Nr. 161-1

Bestell-Nr. 162-1

Kleines Sortiment

64 teilig

64 teilig

INHALTSÜBERSICHT

330	Kleingabelschlüssel 3,5 x 4 4 x 3,5 4,5 x 5 5 x 4,5 5,5 x 6 6 x 5,5 7 x 8 8 x 7 9 x 10 10 x 9 11 x 12 12 x 11	811-9 Werkstattschraubendreher 150 x 8
		813-3 Elektrikerschraubendreher 100 x 3,5
		834-3 Schraubendreher für Vergaser, 25 x 8
450 Rd	Gabelschlüssel (Satz) 6x7 8x9 10x11 12x13 14x15 16x17 18x19 20x22	900Z Zwölfkant-Einsätze 1/2" □ Antrieb
		10 12 13 14 15
		16 17 18 19 20
		21 22 23 24 26
		27 28 30 32
		Betätigungswerkzeuge 1/2" □ Antrieb
		916 Umschaltknarre 12"
		917 Verlängerung 5"
		918 Verlängerung 10"
		920 Universalgelenk
		1801-2 Seitenschneider 6 1/2"
		1850-3 Kombizange 7"
		1950-3 Plastic-Hammer 100 x 32
		2130 Drahtbürste
625	Ringschlüssel, flach gekröpft 8x9 10x11 12x13 14x15 16x17 18x19 20x22	
730-3	Flachmeißel 150 x 18	
740-3	Kreuzmeißel 150 x 8	
745-10	Durchschläger 120 x 2	
746-2	Körner 120 x 12	
760-1	Universalzange 4 1/2"	
760-3	dito 9 1/2"	
761	Zündkerzenschlüssel 21 x 26	

Landmaschinen-Sortiment

Bestell-Nr. **161-11** 74 teilig
 Bestell-Nr. **162-11** 74 teilig

INHALTSÜBERSICHT

430	Steckschlüssel 8x9 10x11 12x13	Betätigungswerkzeuge 1/2" □ Antrieb
450	Gabelschlüssel 6x7 8x9 9x10 10x11 14x15 14x17 17x19 19x22 22x24 24x27 30x36	911 Schwinggriff 16 1/2" 914-15 Winkelgriff 15" 915 T-Griff 12" 916 Umschaltknarre 12" 917 Verlängerung 5" 920 Universalgelenk 980-13 Schraubendreher-Einsatz 13 x 2
630	Ringschlüssel, gekröpft 6x7 8x9 10x11 12x13 14x15 16x17 18x19 20x22 21x23 24x26 25x28 27x30 32x36	1000Z Zwölfkant-Einsätze 3/4" □ Antrieb 36 38 41 46
650-20	Reifenheber 20", 2 Stück	Betätigungswerkzeuge 3/4" □ Antrieb
730-3	Flachmeißel 150 x 18	1015 Schiebegriff 20"
740-3	Kreuzmeißel 150 x 8	1017-8 Verlängerung 8 1/2"
745-13	Durchschläger 120 x 5	1801-2 Seitenschneider 6 1/2"
745-15	dito 120 x 7	Spezialzangen für Seegersicherungen
745-17	dito 120 x 9	1846b-2 innen, abgewinkelt
746-1	Körner 120 x 10	1846c-2 außen, gerade
760-3	Universalzange 9 1/2"	1850-3 Kombizange 7"
815-2	Schraubendreher 125 x 7	1976 Magnetsucher
815-3	dito 150 x 9	2140-3 Schlosserhammer 300 g
815-5	dito 200 x 11	2140-10 dito 1000 g
820-3	Schaber 200	2142 Leichtmetallhammer
832-2	Elektrikerschraubendreher 80 x 3	2147 Fühlerlehre
900Z	Zwölfkant-Einsätze 1/2" □ Antrieb 10 11 14 17 19 22 24 27 30 32	2154 Rollbandmaß, 2 m

Industrie-Sortiment

Bestell-Nr. **162-14** 100 teilig

INHALTSÜBERSICHT

179V-6	Schraubenschlüssel 6", verstellbar	865 Schiebegriff 5"
179V-10	dito 10"	866 Vierkantkegel 5"
450	Gabelschlüssel 6x7 8x9 10x11 12x13 14x15 16x17 18x19 20x22 21x23 24x26 25x28 27x32 36x41	867 Verlängerung 2" 868 Verlängerung 6" 869 Kardangelenke
630	Ringschlüssel, gekröpft 6x7 8x9 10x11 12x13 14x15 16x17 18x19 20x22 21x23 24x26 25x28 27x32	900Z Zwölfkant-Einsätze 1/2" □ Antrieb 10 12 13 14 15 16 17 18 19 20 21 22 23 24 26 27 28 30 32
730-3	Flachmeißel 150 x 18	Betätigungswerkzeuge 1/2" □ Antrieb
730-6	dito 200 x 24	911 Schwinggriff 16 1/2"
740-3	Kreuzmeißel 150 x 8	914-15 Winkelgriff 15"
745-10	Durchschläger 120 x 2	915 T-Griff 12"
745-12	dito 120 x 4	916 Umschaltknarre 12"
746-2	Körner 120 x 12	917 Verlängerung 5"
760-1	Universalzange 4 1/2"	918 Verlängerung 10"
760-3	dito 9 1/2"	920 Universalgelenk
760-4	dito 15"	980-13 Schraubendreher-Einsatz 13 x 2
815-2	Schraubendreher 125 x 7	1801-2 Seitenschneider 6 1/2"
815-4	dito 175 x 10	1807-1 Vorschneider 6 1/2"
815-6	dito 250 x 13	1841a-3 Long-Grip-Zange 8"
832-1	Elektrikerschraubendreher, 60 x 2,5	1850-3 Kombizange 7"
832-4	dito 100 x 4	1852 Figureschere 8"
832-6	dito 140 x 5	1950-4 Plastic-Hammer 105 x 35
850	Sechskant-Einsätze 1/4" □ Antrieb 4 4,5 5 5,5 6 7 8 9 10 11	1980 Metallsäge
	Betätigungswerkzeuge 1/4" □ Antrieb	2120-10 Rundfeile 10"
863	Umschaltknarre 4 1/2"	2122-10 Flachfeile 10"
864	Gelenkgriff 6"	2123-10 Dreikantfeile 10"
		2130 Drahtbürste
		2140-5 Hammer 500 g
		2160 Ölspritzkännchen
		2163 Fettbüchse

Baumaschinen-Sortiment

Bestell-Nr. **162-15** 107 teilig

Dieses Sortiment kann auch im Werkzeugkoffer „Juwel“ unter der Bestell-Nr. HAZET 150-1 bzw. 152-1 geliefert werden (siehe Seite 5 u. 6)

INHALTSÜBERSICHT

320	Ventil-Einstellschlüssel 14 x 14 17 x 17 je 2 Stück	900Z Zwölfkant-Einsätze 1/2" □ Antrieb 10 11 12 14 15 17 19 22 24 27
450	Gabelschlüssel 6x7 8x9 10x11 12x13 14x15 16x17 18x19 20x22 21x23 24x26 27x29 30x32	900AZ Zwölfkant-Einsätze 1/2" □ Antrieb 1 1/16 1 1/8 1 3/16
450A	Gabelschlüssel 1/4 x 5/16 5/16 x 13/32 3/8 x 7/16 1/2 x 9/16 9/16 x 5/8 19/32 x 11/16 5/8 x 3/4 25/32 x 13/16 7/8 x 15/16 15/16 x 1 1 x 1 1/8 1 1/16 x 1 1/4	Betätigungswerkzeuge 1/2" □ Antrieb 911 Schwinggriff 16 1/2" 914-18 Winkelgriff 18" 915 T-Griff 12" 916 Umschaltknarre 12" 917 Verlängerung 5" 918 Verlängerung 10" 920 Universalgelenk
600	Gabel-Ringschlüssel 8 9 10 11 12 14 17 19 21 22 24 27 30 32	1000 Sechskant-Einsätze 3/4" □ Antrieb 22 24 27 30 32 36 41 46 50 55 60
630	Ringschlüssel, gekröpft 10x11 12x13 14x17 19x22 21x23 24x27 30x32 36x41	1000AZ Zwölfkant-Einsatz 3/4" □ Antrieb 1 1/2"
730-4	Flachmeißel 150 x 20	Betätigungswerkzeuge 3/4" □ Antrieb
730-6	dito 200 x 24	1014 Stecker 20"
745-14	Durchschläger 120 x 6	1015 Schiebegriff 20"
745-16	dito 120 x 8	1016 Knarrenkopf 6"
745-18	dito 120 x 10	1017-8 Verlängerung 8 1/2"
746-2	Körner 120 x 12	1020 Gelenkstück 5"
748-7	Splintentreiber 150 x 6	1801-2 Seitenschneider 6 1/2"
748-8	dito 150 x 8	1842 Splintenauszieh-zange 7"
757-10	Universal-Gripzange 10"	Spezialzangen für Seegersicherungen
760-3	Universalzange 9 1/2"	1846a-2 innen, gerade
760-4	dito 15"	1846d-2 außen, abgewinkelt
811-7	Werkstattschraubendreher 150 x 7	1850-2 Kombizange 6 1/2"
811-14	dito 250 x 10	2141-4 Engl. Hammer 2 lbs. 2147 Fühlerlehre

Einzelteile

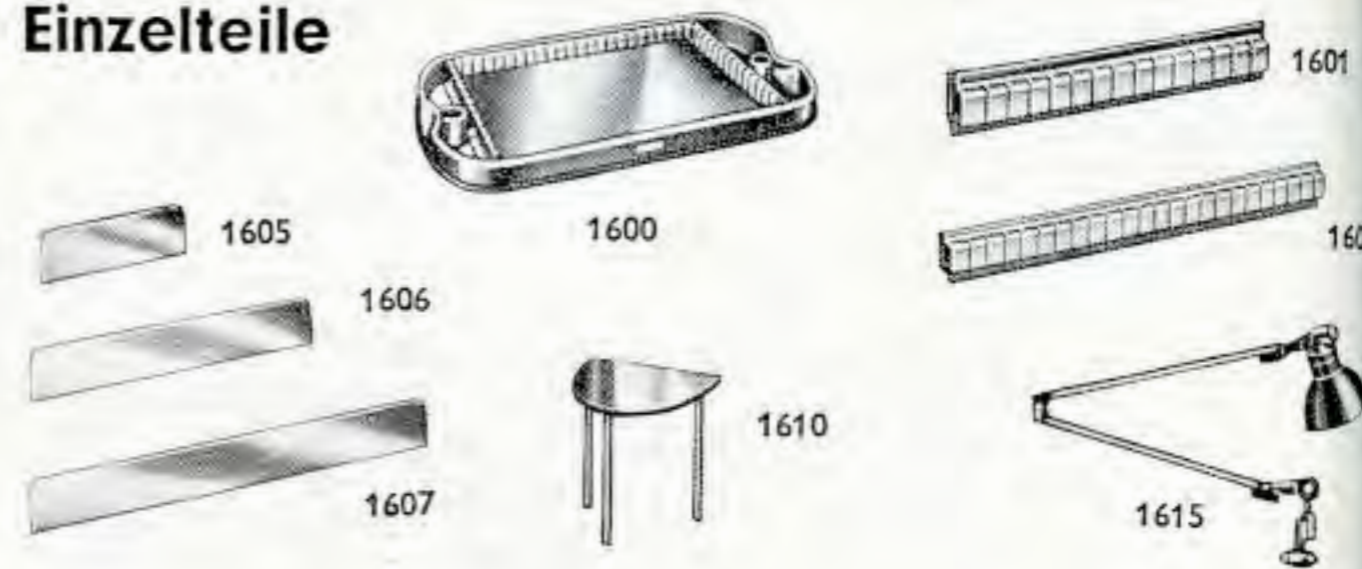

Bestell-Nr.	Bezeichnung	Gewicht g	Preis
1600	Zwischenkasten ohne Trennbleche, mit Aufhängeketten zur Erweiterung der Ausführung 161 auf 162 620 x 330 x 65 mm innen	3640	47.60
1601	Schlitzprofilschiene 310 mm lang	380	6.30
1602	Schlitzprofilschiene 480 mm lang	640	6.90
1605	Trennblech 150 mm lang	60	-.80
1606	Trennblech 310 mm lang	120	1.10
1607	Trennblech 480 mm lang	200	1.50
1610	Hocker	1000	20.90
1615	Leuchte	1500	75.20



Verstellbare Schraubenschlüssel
SPEZIALSTAHL

179



mit Zwölfkant-Ring

Bestell-Nr.	Länge		Zwölfkant-Ring mm	Pack-Norm	Poliert
	mm	Zoll			
179-4	100	4	9	1	6.30
6	150	6	14	1	6.30
8	200	8	17	1	7.60
10	250	10	19	1	9.70
12	300	12	22	1	13.40
15	380	15	—	1	24.80
18	460	18	—	1	43.70

Sätze auf Reklameständern u. Verkaufstafeln

Bestell-Nr.	Inhalt	Preis
R179	4 6 8 10 12" 2 2 2 2 1 Stück	73.20
VT179	4 6 8 10 12" 2 3 3 2 2 Stück	100.50



Verstellbare Schraubenschlüssel
VERCHROMT

179 V



mit Zwölfkant-Ring

Bestell-Nr.	Länge		Zwölfkant-Ring mm	Pack-Norm	Verchromt Hochglanz poliert
	mm	Zoll			
179V-4	100	4	9	1	8.60
6	150	6	14	1	8.60
8	200	8	17	1	10.80
10	250	10	19	1	14.10
12	300	12	22	1	18.90



Magnetschlüssel

310



Sätze am Ring
Metr. Maße

Bestell-Nr.	Inhalt	Glanzvernickelt
310/11	8 Schlüssel Nr. 1 2 3 4 mm 4 4,5 5 5,5 Nr. 5 6 7 8 mm 6 6,5 7 7,5 1 Fühlerlehre 1 Schraubendreher 1 Kontaktfeile	2.90

Amerik. Maße

Bestell-Nr.	Inhalt	Preis
310/11A	8 Schlüssel Zoll 3/16 7/32 1/4 9/32 5/16 11/32 3/8 7/16 1 Fühlerlehre 1 Schraubendreher 1 Kontaktfeile	3.80



Magnetschlüssel

311



Satz mit Doppelriet
Metr. Maße

Bestell-Nr.	Inhalt	Preis
311/10	wie 310/11, jedoch ohne Kontaktfeile	2.20



Ventil-Einstellschlüssel
CHROM-VANADIUM

320

Maulstellung 0° und 22 1/2°



Metr. Maße Gleiche Schlüsselweiten

Bestell-Nr. u. Größe	Länge mm	Pack-Norm	Verchromt Köpfe geschliffen
320			
8 x 8	207	10	5.20
9 x 9	207	10	
10 x 10	207	10	
11 x 11	211	10	5.50
12 x 12	211	10	
13 x 13	217	10	5.60
14 x 14	217	10	
15 x 15	217	10	
16 x 16	221	10	6.—
17 x 17	221	10	
18 x 18	221	10	
19 x 19	224	10	6.50
20 x 20	224	10	
21 x 21	224	10	
22 x 22	224	10	

Amerik. Maße

Bestell-Nr.	Länge mm	Pack-Norm	Verchromt Köpfe geschliffen
320 A			
5/16 x 5/16	207	10	5.20
3/8 x 3/8	207	10	
7/16 x 7/16	211	10	5.50
1/2 x 1/2	217	10	
9/16 x 9/16	217	10	5.60
19/32 x 19/32	217	10	
5/8 x 5/8	221	10	6.—
11/16 x 11/16	221	10	
3/4 x 3/4	224	10	6.50
25/32 x 25/32	224	10	
7/8 x 7/8	224	10	

Sätze in hausfarbenen HAZET-Schachteln
Metr. Maße

Bestell-Nr.	Inhalt	Verchromt Köpfe geschliffen
320/7	12 13 14 15 16 17 18	40.30
320/15	8 9 10 11 12 13 14 15 16 17 18 19 20 21 22	87.40

Amerik. Maße

Bestell-Nr.	Inhalt	Preis
320/7A	7/16 1/2 9/16 5/8 11/16 3/4 7/8	41.70



Ventil-Einstellschlüssel
CHROM-VANADIUM

320



Metr. Maße Ungleiche Schlüsselweiten

Bestell-Nr. u. Größe	Länge mm	Pack-Norm	Verchromt Köpfe geschliffen
320			
8 x 9	207	10	5.20
10 x 11	207	10	
12 x 13	211	10	5.50
14 x 15	217	10	
16 x 17	221	10	6.—
18 x 19	221	10	
20 x 22	224	10	6.50

Amerik. Maße

Bestell-Nr.	Länge mm	Pack-Norm	Verchromt Köpfe geschliffen
320 A			
1/4 x 5/16	207	10	5.20
3/8 x 7/16	207	10	
7/16 x 1/2	211	10	5.50
1/2 x 9/16	217	10	
5/8 x 11/16	221	10	6.—
3/4 x 7/8	224	10	



Ventil-Einstellschlüssel
CHROM-VANADIUM

320



Engl. Maße Ungleiche Schlüsselweiten

Bestell-Nr. u. Größe	Länge mm	Pack-Norm	Verchromt Köpfe geschliffen
320 W			
3/16 x 1/4	211	10	5.50
1/4 x 5/16	217	10	
5/16 x 3/8	221	10	6.—
3/8 x 7/16	224	10	

Sätze in hausfarbenen HAZET-Schachteln
Metr. Maße

Bestell-Nr.	Inhalt	Verchromt Köpfe geschliffen
320/7 U	8x9 10x11 12x13 14x15 16x17 18x19 20x22	40.—

Amerik. Maße

Bestell-Nr.	Inhalt	Preis
320/6 AU	1/4 x 5/16 3/8 x 7/16 7/16 x 1/2 1/2 x 9/16 5/8 x 11/16 3/4 x 7/8	34.—

Engl. Maße

Bestell-Nr.	Inhalt	Preis
320/4 WU	3/16 x 1/4 1/4 x 5/16 5/16 x 3/8 3/8 x 7/16	23.60



Ventil-Einstellschlüssel
CHROM-VANADIUM
kurze Form
Maulstellung 0° und 30°

325



Bestell-Nr. u. Größe	Länge mm	Pack-Norm	Verchromt
325			
14 x 14	150	10	5.20



Spezialwerkzeug
CHROM-VANADIUM
für Ventileinstellung
mit Schraubendreher

327



Bestell-Nr.	Schlüsselweite mm	Länge mm	Pack-Norm	Verchromt
327	14	440	1	40.20
327-1	loser Schlüssel		1	30.10
327-2	loser Schraubendreher		1	10.10



Spezialwerkzeug
CHROM-VANADIUM
für Ventileinstellung
mit Schraubendreher

328

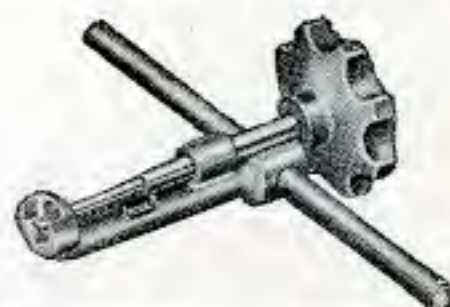

Bestell-Nr.	Schlüsselweite mm	Länge mm	Pack-Norm	Verchromt
328	14	130	1	35.40
328-1	loser Schlüssel		1	26.60
328-2	loser Schraubendreher		1	8.80



Kleingabelschlüssel CHROM-VANADIUM

330

Maulstellung: 15° und 60°



Metr. Maße

Bestell-Nr. u. Größe	Länge mm	Pack-Norm	Verchromt Köpfe geschliffen
330			
3,5 x 4	80	10	2.70
4 x 3,5	80	10	
4,5 x 5	80	10	
5 x 4,5	80	10	
5,5 x 6	80	10	
6 x 5,5	80	10	
7 x 8	90	10	3.10
8 x 7	90	10	
9 x 10	100	10	3.20
10 x 9	100	10	
11 x 12	112	10	3.40
12 x 11	112	10	
13 x 14	120	10	3.60
14 x 13	120	10	

Amerik. Maße

Bestell-Nr. u. Größe	Länge mm	Pack-Norm	Verchromt Köpfe geschliffen
330 A			
3/16 x 13/64	80	10	2.70
13/64 x 3/16	80	10	
13/64 x 15/64	80	10	
15/64 x 13/64	80	10	
7/32 x 15/64	80	10	
15/64 x 7/32	80	10	
7/32 x 1/4	80	10	3.10
1/4 x 7/32	80	10	
1/4 x 9/32	90	10	
9/32 x 1/4	90	10	
9/32 x 5/16	90	10	
5/16 x 9/32	90	10	
17/64 x 19/64	90	10	3.20
19/64 x 17/64	90	10	
5/16 x 11/32	100	10	
11/32 x 5/16	100	10	
11/32 x 3/8	100	10	3.40
3/8 x 11/32	100	10	
3/8 x 7/16	112	10	
7/16 x 3/8	112	10	3.40
7/16 x 1/2	112	10	

Engl. Maße

Bestell-Nr. u. Größe	Länge mm	Pack-Norm	Verchromt Köpfe geschliffen
330 BA			
9 BA x 8 BA	80	10	2.70
8 BA x 9 BA	80	10	
7 BA x 6 BA	80	10	
6 BA x 7 BA	80	10	
5 BA x 4 BA	80	10	
4 BA x 5 BA	80	10	
3 BA x 2 BA	90	10	3.10
2 BA x 3 BA	90	10	
1 BA x 0 BA	100	10	3.20
0 BA x 1 BA	100	10	

Sätze in hausfarbenen HAZET-Schachteln oder Plastic-Taschen

Metr. Maße

Bestell-Nr.	Inhalt	Verchromt Köpfe geschliffen
330/14	3,5 x 4 4,5 x 5 5,5 x 6 7 x 8 9 x 10 11 x 12 13 x 14	4 x 3,5 5 x 4,5 6 x 5,5 8 x 7 10 x 9 12 x 11 14 x 13
330/14 P	wie vor, jedoch in Plastic-Tasche	42.80
		48.20



Kleingabelschlüssel CHROM-VANADIUM

330



Sätze (Fortsetzung)

Amerik. Maße

Bestell-Nr.	Inhalt	Verchromt Köpfe geschliffen
330/6 A	7/32 x 15/64 15/64 x 7/32 1/4 x 9/32 9/32 x 1/4 5/16 x 11/32 11/32 x 5/16	18.—
330/6 AP	wie vor, jedoch in Plastic-Tasche	21.80
330/9 A	13/64 x 15/64 15/64 x 13/64 7/32 x 1/4 1/4 x 7/32 9/32 x 5/16 5/16 x 9/32 11/32 x 3/8 3/8 x 11/32 7/16 x 1/2	26.80
330/9 AP	wie vor, jedoch in Plastic-Tasche	30.60



Steckschlüssel CHROM-VANADIUM

430

aus dem Vollen geschmiedet und ausgebohrt



Bestell-Nr. u. Größe	Länge mm	Pack-Norm	Verchromt Köpfe geschliffen
430			
6 x 7	115	10	4.60
8 x 9	120	10	4.90
8 x 10	120	10	
9 x 10	120	10	5.10
9 x 11	130	10	
10 x 11	130	10	5.80
11 x 14	140	10	
12 x 13	140	10	
12 x 14	140	10	6.60
13 x 15	150	10	
14 x 15	150	10	7.80
14 x 17	160	10	
16 x 17	160	10	9.30
17 x 19	170	10	
18 x 19	170	10	10.40
19 x 22	180	10	
20 x 22	180	10	11.30
21 x 23	180	5	
22 x 24	190	5	12.40
24 x 26	190	5	
24 x 27	190	5	
25 x 28	190	5	13.60
27 x 29	200	5	14.20
27 x 30	200	5	
27 x 32	200	5	17.50
30 x 32	200	5	
32 x 36	250	5	26.40



Steckschlüssel CHROM-VANADIUM

430



Sätze in hausfarbenen HAZET-Schachteln

Bestell-Nr.	Inhalt	Verchromt Köpfe geschliffen
430/7	8 x 9 10 x 11 12 x 13 14 x 15 16 x 17 18 x 19 20 x 22	49.90
430/8	6 x 7 8 x 9 10 x 11 12 x 13 14 x 15 16 x 17 18 x 19 20 x 22	54.50
430/12	8 x 9 10 x 11 12 x 13 14 x 15 16 x 17 18 x 19 20 x 22 21 x 23 24 x 26 25 x 28 27 x 29 30 x 32	118.90



Steckschlüssel CHROM-VANADIUM

430



Kastengröße: 430 x 210 x 50 mm

Satz im hausfarbenen HAZET-Metallkasten

Bestell-Nr.	Inhalt	Verchromt Köpfe geschliffen
430/12 K	8 x 9 10 x 11 12 x 13 14 x 15 16 x 17 18 x 19 20 x 22 21 x 23 24 x 26 25 x 28 27 x 29 30 x 32 433 - 0619, - 2032	153.40



Steckschlüssel CHROM-VANADIUM

430

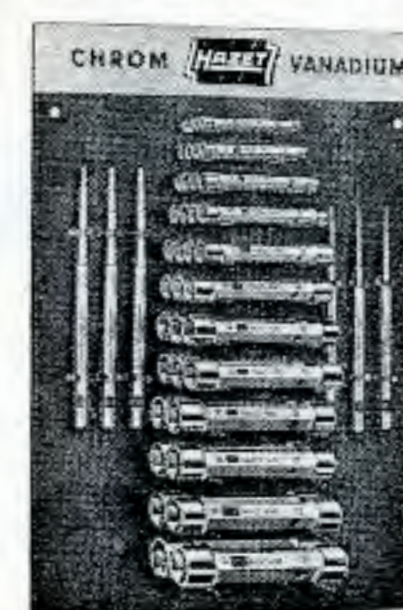

Sätze auf Verkaufstafeln

Bestell-Nr.	Inhalt	Verchromt Köpfe geschliffen
VT 430/43	8 x 9 - 16 x 17 je 4 St. 18 x 19 - 21 x 23 je 3 St. 24 x 26 - 30 x 32 je 2 St. 433 - 0619, - 2032 je 3 St.	358.60



Drehstifte CHROM-VANADIUM

433



stufenförmig

Bestell-Nr.	für Schlüssel	Länge mm	Verchromt
433-0619	6-19	250	4.60
2032	20-32	280	5.20
3236	32-36	450	6.50



**Gabelschlüssel
CHROM-VANADIUM**

450

lange schlanke Form



Metr. Maße

Bestell-Nr. u. Größe	Länge mm	Pack- Norm	Verchr. Köpfe Hochgl.	Verchr.
450				
4 x 5	100	10	2.60	2.—
5 x 6	100	10		
6 x 7	122	10	2.70	2.10
6 x 8	122	10		
7 x 8	122	10		
7 x 9	140	10	3.—	2.30
8 x 9	140	10		
8 x 10	140	10		
9 x 10	140	10		
9 x 11	156	10	3.20	2.50
10 x 11	156	10		
10 x 12	156	10		
11 x 12	156	10		
10 x 14	172	10	3.50	2.90
11 x 13	172	10		
11 x 14	172	10		
12 x 13	172	10		
12 x 14	172	10		
13 x 14	190	10	3.90	3.—
13 x 15	190	10		
14 x 15	190	10		
14 x 16	190	10		
15 x 16	190	10		
13 x 17	205	10	4.40	3.30
14 x 17	205	10		
16 x 17	205	10		
16 x 18	205	10		
17 x 19	220	10	4.70	3.50
18 x 19	220	10		
18 x 20	220	10		
17 x 22	236	10	5.10	3.70
19 x 22	236	10		
20 x 22	236	10		
19 x 24	250	10	5.30	3.90
21 x 23	250	10		
22 x 24	250	10		
22 x 27	265	10	6.70	4.90
24 x 26	265	10		
24 x 27	265	10		
24 x 30	280	10	6.90	5.20
25 x 27	280	10		
25 x 28	280	10		
26 x 28	280	10		
26 x 29	300	10	8.40	6.20
27 x 29	300	10		
27 x 30	300	10		
27 x 32	300	10		
28 x 30	300	10		
30 x 32	300	10		
30 x 36	325	5	14.50	10.40
32 x 35	325	5		
32 x 36	325	5		
36 x 41	360	1	22.40	17.20
38 x 42	360	1		
41 x 46	400	1	32.80	25.60
46 x 50	450	1	43.40	32.90



**Gabelschlüssel
CHROM-VANADIUM**

450



Amerik. Maße

Bestell-Nr. u. Größe	Länge mm	Pack- Norm	Verchr. Köpfe Hochgl.	Verchr.
450 A				
1/4 x 5/16	122	10	2.70	2.10
5/16 x 3/8	140	10	3.—	2.30
5/16 x 13/32	140	10		
3/8 x 7/16	156	10	3.20	2.50
7/16 x 1/2	172	10	3.50	2.90
1/2 x 9/16	172	10		
1/2 x 19/32	190	10	3.90	3.—
9/16 x 5/8	190	10		
9/16 x 11/16	205	10	4.40	3.30
19/32 x 11/16	205	10		
5/8 x 11/16	205	10		
5/8 x 3/4	220	10	4.70	3.50
5/8 x 25/32	220	10		
11/16 x 3/4	220	10		
11/16 x 25/32	220	10		
11/16 x 13/16	220	10		
3/4 x 25/32	220	10		
11/16 x 7/8	236	10	5.10	3.70
3/4 x 7/8	236	10		
25/32 x 13/16	236	10		
25/32 x 7/8	236	10		
13/16 x 7/8	236	10		
7/8 x 15/16	250	10	5.30	3.90
7/8 x 31/32	250	10		
7/8 x 1 1/16	265	10	6.70	4.90
15/16 x 1	265	10		
15/16 x 1 1/16	265	10		
1 x 1 1/8	280	10	6.90	5.20
1 1/16 x 1 1/8	280	10		
1 1/16 x 1 1/4	300	10	8.40	6.20
1 3/16 x 1 5/16	300	10		
1 1/16 x 1 7/16	300	10		
1 1/4 x 1 3/8	325	5	14.50	10.40
1 1/4 x 1 7/16	325	5		
1 5/16 x 1 1/2	325	5		
1 3/8 x 1 1/2	325	5		
1 7/16 x 1 5/8	360	1	22.40	17.20
1 5/16 x 1 11/16	360	1		
1 5/16 x 1 13/16	360	1		
1 1/2 x 1 5/8	360	1		
1 1/2 x 1 3/4	360	1		
1 5/8 x 1 13/16	400	1	32.80	25.60
1 11/16 x 1 7/8	400	1		
1 13/16 x 2	450	1	43.40	32.90
1 3/4 x 2 1/16	450	1		
Engl. Maße				
450 W				
1/16 x 3/32	122	10	2.70	2.10
3/32 x 1/8	140	10	3.—	2.30
1/8 x 3/16	156	10	3.20	2.50
3/16 x 1/4	172	10	3.50	2.90
1/4 x 5/16	190	10	3.90	3.—
5/16 x 3/8	205	10	4.40	3.30
3/8 x 7/16	236	10	5.10	3.70
7/16 x 1/2	250	10	5.30	3.90
1/2 x 9/16	265	10	6.70	4.90
1/2 x 5/8	265	10		
9/16 x 5/8	280	10	6.90	5.20
9/16 x 11/16	280	10		
5/8 x 3/4	300	10	8.40	6.20
11/16 x 3/4	300	10		
11/16 x 13/16	325	5	14.50	10.40
3/4 x 7/8	325	5		
7/8 x 1	360	1	22.40	17.20
1 x 1 1/8	400	1	32.80	25.60
1 1/8 x 1 1/4	450	1	43.40	32.90



**Gabelschlüssel
CHROM-VANADIUM**

450



Sätze in hausfarbenen HAZET-Schachteln

Metr. Maße

Bestell-Nr.	Inhalt	Verchr. Köpfe Hochgl.	Verchr.
450/6	8 x 9 12 x 13 16 x 17	10 x 11 14 x 15 18 x 19	22.70 17.50
450/7	6 x 7 10 x 11 14 x 15 18 x 19	8 x 9 12 x 13 16 x 17	25.40 19.60
450/7 I	8 x 9 12 x 13 16 x 17 20 x 22	10 x 11 14 x 15 18 x 19	27.80 21.20
450/8	6 x 7 10 x 11 14 x 15 18 x 19	8 x 9 12 x 13 16 x 17 20 x 22	30.50 23.30
450/10	6 x 7 10 x 11 14 x 15 18 x 19 24 x 26	8 x 9 12 x 13 16 x 17 20 x 22 27 x 32	45.60 34.40
450/10 I	6 x 7 10 x 11 14 x 15 18 x 19 24 x 27	8 x 9 12 x 13 16 x 17 20 x 22 30 x 32	45.60 34.40
450/12	6 x 7 10 x 11 14 x 15 18 x 19 21 x 23 25 x 28	8 x 9 12 x 13 16 x 17 20 x 22 24 x 26 27 x 32	57.80 43.50
450/12 I	6 x 7 10 x 11 14 x 15 18 x 19 21 x 23 27 x 29	8 x 9 12 x 13 16 x 17 20 x 22 24 x 26 30 x 32	59.30 44.50
450/12 II	6 x 7 10 x 11 14 x 15 18 x 19 21 x 23 25 x 27	8 x 9 12 x 13 16 x 17 20 x 22 24 x 26 30 x 32	57.80 43.50
450/13	6 x 7 10 x 11 14 x 15 18 x 19 21 x 23 25 x 28 36 x 41	8 x 9 12 x 13 16 x 17 20 x 22 24 x 26 27 x 32	80.20 60.70
Amerik. Maße			
450/5A	1/4 x 5/16 1/2 x 9/16 5/8 x 3/4	3/8 x 7/16 19/32 x 11/16	18.50 14.30
450/6A I	5/16 x 13/32 1/2 x 9/16 5/8 x 3/4	3/8 x 7/16 19/32 x 11/16 25/32 x 7/8	23.90 18.20
450/6A III	3/8 x 7/16 19/32 x 11/16 25/32 x 7/8	1/2 x 9/16 5/8 x 3/4 15/16 x 1	27.60 20.80
450/7A	5/16 x 3/8 9/16 x 5/8 13/16 x 7/8 1 1/16 x 1 1/8	7/16 x 1/2 11/16 x 3/4 15/16 x 1	33.80 25.50
450/8A	1/4 x 5/16 3/8 x 7/16 19/32 x 11/16 25/32 x 7/8	5/16 x 13/32 1/2 x 9/16 5/8 x 3/4 15/16 x 1	33.30 25.20

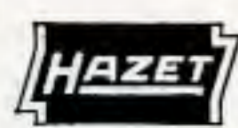

**Gabelschlüssel
CHROM-VANADIUM**

450



Sätze in hausfarbenen HAZET-Schachteln
Amerik. Maße (Fortsetzung)

Bestell-Nr.	Inhalt	Verchr. Köpfe Hochgl.	Verchr.
450/10A	1/4 X 5/16 5/16 X 3/8 3/8 X 7/16 7/16 X 1/2 1/2 X 9/16 9/16 X 5/8 5/8 X 3/4 3/4 X 7/8 7/8 X 15/16 15/16 X 1		41.60 31.70
450/12A	1/4 X 5/16 5/16 X 13/32 3/8 X 7/16 1/2 X 9/16 9/16 X 5/8 19/32 X 11/16 5/8 X 3/4 25/32 X 13/16 7/8 X 15/16 15/16 X 1 1 X 1 1/8 1 1/16 X 1 1/4		57.80 43.50
Engl. Maße			
450/6W	1/8 X 3/16 3/16 X 1/4 1/4 X 5/16 5/16 X 3/8 3/8 X 7/16 7/16 X 1/2		25.40 19.30
450/8W	1/16 X 3/32 3/32 X 1/8 1/8 X 3/16 3/16 X 1/4 1/4 X 5/16 5/16 X 3/8 3/8 X 7/16 7/16 X 1/2		31.10 23.70
450/9W	1/8 X 3/16 3/16 X 1/4 1/4 X 5/16 5/16 X 3/8 3/8 X 7/16 7/16 X 1/2 1/2 X 9/16 9/16 X 5/8 5/8 X 3/4		47.40 35.60
450/12W	1/8 X 3/16 3/16 X 1/4 1/4 X 5/16 5/16 X 3/8 3/8 X 7/16 7/16 X 1/2 1/2 X 9/16 9/16 X 5/8 5/8 X 3/4 11/16 X 13/16 3/4 X 7/8 7/8 X 1		98.80 73.60



**Gabelschlüssel
CHROM-VANADIUM**

450

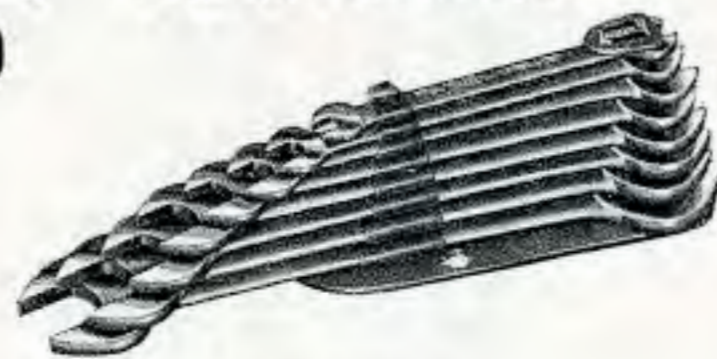

Sätze in „Remscheid“-Haltern
und hausfarbenen HAZET-Schachteln
Metr. Maße

Bestell-Nr.	Inhalt	Verchr. Köpfe Hochgl.	Verchr.
450/8 Rd	6 x 7 8 x 9 10 x 11 12 x 13 14 x 15 16 x 17 18 x 19 20 x 22		33.50 26.30
450/10 Rd	6 x 7 8 x 9 10 x 11 12 x 13 14 x 15 16 x 17 18 x 19 20 x 22 24 x 26 27 x 32		49.90 38.70
450/12 Rd	6 x 7 8 x 9 10 x 11 12 x 13 14 x 15 16 x 17 18 x 19 20 x 22 21 x 23 24 x 26 25 x 28 27 x 32		62.80 48.50



**Gabelschlüssel
CHROM-VANADIUM**

450

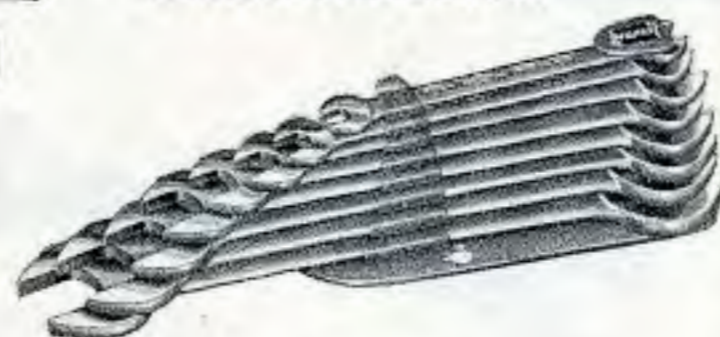

Sätze in „Remscheid“-Haltern
und hausfarbenen HAZET-Schachteln
Amerik. Maße

Bestell-Nr.	Inhalt	Verchr. Köpfe Hochgl.	Verchr.
450/6A I Rd	5/16 X 13/32 3/8 X 7/16 1/2 X 9/16 19/32 X 11/16 5/8 X 3/4 25/32 X 7/8		26.50 20.80
450/6A III Rd	3/8 X 7/16 1/2 X 9/16 19/32 X 11/16 5/8 X 3/4 25/32 X 7/8 15/16 X 1		30.20 23.40
450/7A Rd	5/16 X 3/8 7/16 X 1/2 9/16 X 5/8 11/16 X 3/4 13/16 X 7/8 15/16 X 1 1 1/16 X 1 1/8		36.80 28.50
450/8A Rd	1/4 X 5/16 5/16 X 13/32 3/8 X 7/16 1/2 X 9/16 19/32 X 11/16 5/8 X 3/4 25/32 X 7/8 15/16 X 1		36.30 28.20
450/12A Rd	1/4 X 5/16 5/16 X 13/32 3/8 X 7/16 1/2 X 9/16 9/16 X 5/8 19/32 X 11/16 5/8 X 3/4 25/32 X 13/16 7/8 X 15/16 15/16 X 1 1 X 1 1/8 1 1/16 X 1 1/4		62.80 48.50
Engl. Maße			
450/6W Rd	1/8 X 3/16 3/16 X 1/4 1/4 X 5/16 5/16 X 3/8 3/8 X 7/16 7/16 X 1/2		28.— 21.90
450/8W Rd	1/16 X 3/32 3/32 X 1/8 1/8 X 3/16 3/16 X 1/4 1/4 X 5/16 5/16 X 3/8 3/8 X 7/16 7/16 X 1/2		34.10 26.70

Sätze auf Reklameständern aus Plastic
(siehe Seite 10)

R 450/8	6 x 7 - 20 x 22	30.50	23.30
R 450/12	6 x 7 - 27 x 32	57.80	43.50
R 450/8A	1/4 X 5/16 - 15/16 X 1	33.30	25.20
R 450/12A	1/4 X 5/16 - 1 1/16 X 1 1/4	57.80	43.50
R 450/8W	1/16 X 3/32 - 7/16 X 1/2	31.10	23.70
R 450/12W	1/8 X 3/16 - 7/8 X 1	98.80	73.60



**Gabelschlüssel
CHROM-VANADIUM**

450



Sätze auf Verkaufstafeln
Metr. Maße

VT 450/39	6 x 7 - 16 x 17 je 4 St. 18 x 19 - 21 x 23 je 3 St. 24 x 26 - 27 x 32 je 2 St.	172.10	130.30
Amerik. Maße			
VT 450/39 A	1/4 X 5/16 - 19/32 X 11/16 je 4 Stück 5/8 X 3/4 - 7/8 X 15/16 je 3 Stück 15/16 X 1 - 1 1/16 X 1 1/4 je 2 Stück	172.10	130.30



**Gabel-Ringschlüssel
CHROM-VANADIUM**

600

lange Form, schlank und dünnwandig, Ringschlüsselkopf 15° abgebogen



Metr. Maße Gleiche Schlüsselweiten

Bestell-Nr. u. Größe	Länge mm	Pack-Norm	Verchromt Köpfe Hochglanz
600			
6	102	10	2.90
7	112	10	
8	125	10	3.10
9	145	10	3.40
10	165	10	3.60
11	172	10	3.70
12	180	10	4.20
13	190	10	4.50
14	200	10	4.70
15	215	10	5.—
16	230	10	5.30
17	240	10	5.90
18	255	10	6.20
19	265	10	6.70
20	280	10	
21	280	10	7.30
22	300	10	8.10
23	325	5	
24	325	5	9.—
25	355	5	
26	355	5	10.40
27	385	5	
28	385	5	12.20
30	430	1	
32	430	1	14.70
36	490	1	17.80
41	535	1	21.60

Amerik. Maße

600 A			
1/4	102	10	2.90
5/16	125	10	3.10
3/8	165	10	3.60
7/16	172	10	3.70
1/2	190	10	4.50
9/16	200	10	4.70
5/8	230	10	5.30
11/16	240	10	5.90
3/4	265	10	6.70
13/16	280	10	7.30
7/8	300	10	8.10
15/16	325	5	9.—
1	355	5	10.40
1 1/16	385	5	
1 1/8	385	5	12.20
1 1/4	430	1	
1 5/16	430	1	14.70
1 3/8	490	1	
1 7/16	490	1	17.80
1 1/2	490	1	
1 5/8	535	1	21.60



Gabel-Ringschlüssel
CHROM-VANADIUM

600



Engl. Maße

Bestell-Nr. u. Größe	Länge mm	Pack-Norm	Verchromt Köpfe Hochglanz
600 W			
1/8	145	10	3.40
3/16	172	10	3.70
1/4	190	10	4.50
5/16	215	10	5.—
3/8	255	10	6.20
7/16	280	10	7.30
1/2	300	10	8.10
9/16	355	5	10.40
5/8	385	5	12.20
11/16	430	1	14.70
3/4	430	1	14.70
13/16	490	1	17.80
7/8	490	1	17.80
15/16	535	1	21.60
1	535	1	21.60



Gabel-Ringschlüssel
CHROM-VANADIUM

600

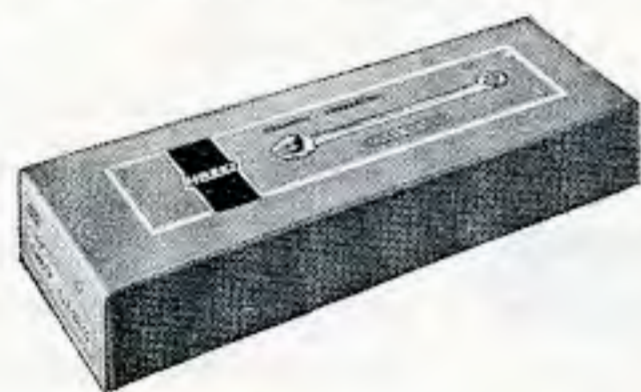

Sätze in hausfarbenen HAZET-Schachteln

Metr. Maße

Bestell-Nr.	Inhalt	Verchr. Köpfe Hochgl.
600/6	9 11 14 17 19 22	32.50
600/8	9 11 14 17 19 22 27 32	59.40
600/10	8 9 11 14 17 19 22 24 27 32	71.50
600/12	6 7 9 11 13 14 17 19 22 24 27 32	78.70
600/17	alle Schlüssel von 6-22	84.80
600/25	alle Schlüssel von 6-32	177.40
600/27	alle Schlüssel von 6-41	216.80

Amerik. Maße

600/6 A I	5/16 3/8 7/16 1/2 9/16 5/8	24.90
600/6 A II	7/16 1/2 9/16 5/8 3/4 7/8	33.—
600/8 A I	3/8 7/16 1/2 9/16 5/8 3/4 7/8 1	47.—
600/10 A	1/4 5/16 3/8 7/16 1/2 9/16 5/8 3/4 7/8 1	53.—
600/12 A I	1/4 5/16 3/8 7/16 1/2 9/16 5/8 3/4 7/8 1 1 1/8 1 5/16	79.90

Engl. Maße

600/6 W	3/16 1/4 5/16 7/16 1/2 5/8	40.80
600/7 W	1/8 3/16 1/4 5/16 3/8 7/16 1/2	38.20
600/8 W	1/8 3/16 1/4 5/16 3/8 7/16 1/2 9/16	48.60
600/10 W	1/8 3/16 1/4 5/16 3/8 7/16 1/2 9/16 5/8 3/4	75.50

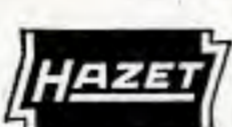

Gabel-Ringschlüssel
CHROM-VANADIUM

600

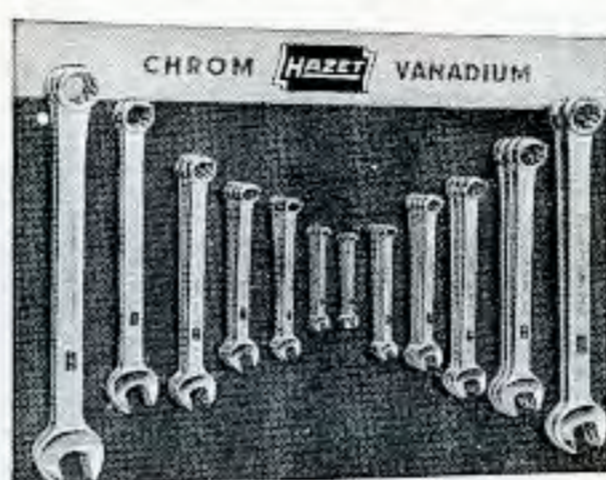

Sätze auf Verkaufstafeln

Metr. Maße

Bestell-Nr.	Inhalt	Verchromt Köpfe Hochglanz
VT 600/39	6 7 9 11 13 14 je 4 Stück 17 19 22 je 3 Stück 24 27 32 je 2 Stück	220.30

Amerik. Maße

VT 600/39A	1/4 5/16 3/8 7/16 1/2 9/16 je 4 Stück 5/8 3/4 7/8 je 3 Stück 1 1 1/8 1 5/16 je 2 Stück	224.90
-------------------	---	--------



Gabel-Ringschlüssel
CHROM-VANADIUM

605

kurze Form, schlank und dünnwandig, Ringschlüsselkopf 15° abgebogen



Metr. Maße

Gleiche Schlüsselweiten

Bestell-Nr. u. Größe	Länge mm	Pack-Norm	Verchromt Köpfe Hochglanz
605			
6	95	10	2.20
7	100	10	2.20
8	105	10	2.40
9	110	10	2.40
10	117	10	2.90
11	125	10	2.90
12	130	10	3.20
13	135	10	3.20
14	140	10	3.50
15	148	10	3.50
16	155	10	4.10
17	162	10	4.10
18	170	10	4.90
19	178	10	4.90
20	185	10	5.50
21	195	10	5.50
22	205	10	6.50

Amerik. Maße

605 A			
1/4	95	10	2.20
5/16	105	10	2.40
11/32	105	10	2.40
3/8	110	10	2.40
7/16	125	10	2.90
1/2	135	10	3.20
9/16	140	10	3.50
5/8	155	10	4.10
11/16	162	10	4.10
3/4	178	10	4.90
13/16	195	10	5.50
7/8	205	10	6.50



Gabel-Ringschlüssel
CHROM-VANADIUM

605



Engl. Maße

Bestell-Nr. u. Größe	Länge mm	Pack-Norm	Verchromt Köpfe Hochglanz
605 W			
1/16	95	10	2.20
1/8	105	10	2.40
1 BA	110	10	2.40
0 BA	117	10	2.90
3/16	125	10	2.90
1/4	135	10	3.20
5/16	148	10	3.50
3/8	170	10	4.90
7/16	195	10	5.50
1/2	205	10	6.50



Gabel-Ringschlüssel
CHROM-VANADIUM

605

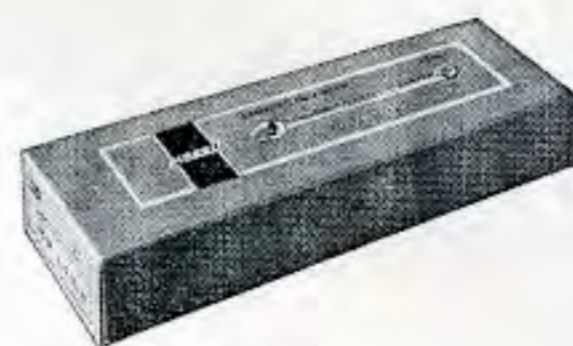

Sätze in hausfarbenen HAZET-Schachteln

Metr. Maße

Bestell-Nr.	Inhalt	Verchromt Köpfe Hochglanz
605/6	9 11 14 17 19 22	24.30
605/8	6 7 8 9 10 11 12 13	21.40
605/12	6 7 8 9 10 11 12 13 14 17 19 22	40.40
605/17	6 7 8 9 10 11 12 13 14 15 16 17 18 19 20 21 22	63.90

Amerik. Maße

605/7 A	5/16 3/8 7/16 1/2 9/16 5/8 3/4	23.40
605/7 A I	1/4 5/16 3/8 7/16 1/2 9/16 5/8	20.70
605/8 A	3/8 7/16 1/2 9/16 5/8 11/16 3/4 7/8	31.60
605/11 A	1/4 5/16 3/8 7/16 1/2 9/16 5/8 11/16 3/4 13/16 7/8	41.70

Engl. Maße

605/6 W	3/16 1/4 5/16 3/8 7/16 1/2 5/8	26.50
605/7 W	1/8 1 BA 0 BA 3/16 1/4 5/16 3/8	22.20
605/10 W	1/16 1/8 1 BA 0 BA 3/16 1/4 5/16 3/8 7/16 1/2	36.40



**Ringschlüssel
CHROM-VANADIUM
gerade**

610



Bestell-Nr. u. Größe	Länge mm	Pack-Norm	Verchromt Köpfe geschliffen
610			
6 x 7	100	10	2.30
8 x 9	115	10	2.50
8 x 10	125	10	2.70
9 x 11	130	10	3.10
10 x 11	130	10	
12 x 14	150	10	
13 x 14	160	10	3.70
13 x 15	160	10	
14 x 15	160	10	
13 x 17	170	10	4.—
14 x 17	170	10	
16 x 17	175	10	4.40
16 x 18	175	10	
17 x 19	185	10	4.70
18 x 19	190	10	4.90
19 x 22	210	10	5.90
20 x 22	210	10	
21 x 23	235	5	6.60
22 x 24	235	5	
24 x 26	260	5	7.10
22 x 27	275	5	7.70
24 x 27	275	5	
25 x 28	290	5	8.40
27 x 30	320	5	9.90
27 x 32	320	5	
30 x 32	320	5	
30 x 36	360	5	11.40
32 x 36	360	5	
36 x 41	400	1	12.20



**Ringschlüssel
CHROM-VANADIUM**

610



Sätze in hausfarbenen HAZET-Schachteln

Bestell-Nr.	Inhalt	Verchromt Köpfe geschliffen
610/6	8 x 9 10 x 11 12 x 13 14 x 15 16 x 17 18 x 19	21.80
610/8	6 x 7 8 x 9 10 x 11 12 x 13 14 x 15 16 x 17 18 x 19 20 x 22	30.—
610/10	6 x 7 8 x 9 10 x 11 12 x 13 14 x 15 16 x 17 18 x 19 20 x 22 24 x 26 27 x 32	47.—
610/10 I	6 x 7 8 x 9 10 x 11 12 x 13 14 x 15 16 x 17 18 x 19 20 x 22 24 x 27 30 x 32	47.60
610/12	6 x 7 8 x 9 10 x 11 12 x 13 14 x 15 16 x 17 18 x 19 20 x 22 21 x 23 24 x 26 25 x 28 27 x 32	62.—



**Ringschlüssel
CHROM-VANADIUM**

610



Sätze auf Verkaufstafeln

Bestell-Nr.	Inhalt	Verchromt Köpfe geschliffen
VT 610/39	6x7 - 16x17 je 4 Stück 18x19 - 21x23 je 3 Stück 24x26 - 27x32 je 2 Stück	179.80

Sätze auf Reklameständern aus Plastic (siehe Seite 10)

R 610/8	6x7 - 20x22	30.—
R 610/12	6x7 - 27x32	62.—



**Starter- und Blockschlüssel
CHROM-VANADIUM**

615



Metr. Maße

Bestell-Nr. u. Größe	Länge mm	Pack-Norm	Verchromt Köpfe geschliffen
615			
11 x 13	145	10	5.70
14 x 16	185	10	6.60
14 x 17	185	10	
15 x 17	185	10	8.70
19 x 22	235	5	

Amerik. Maße

615 A			
7/16 x 1/2	145	10	5.70
9/16 x 5/8	185	10	6.60
5/8 x 3/4	235	5	8.70
3/4 x 7/8	235	5	

Engl. Maße

615 W			
3/16 x 1/4	145	5	5.70
1/4 x 5/16	185	5	6.60
3/8 x 7/16	235	5	8.70

Sätze in hausfarbenen HAZET-Schachteln

Metr. Maße

Bestell-Nr.	Inhalt	Verchromt Köpfe geschliffen
615/3	11 x 13 14 x 17 19 x 22	21.—

Amerik. Maße

615/3 A	7/16 x 1/2 9/16 x 5/8 5/8 x 3/4	21.—
----------------	---------------------------------------	------



**Spezialschlüssel
für den Öldienst
CHROM-VANADIUM**

616 T



auf hausfarbener Plastic-Tafel
Maße: 420 x 300 mm

Bestell-Nr.	Inhalt	Verchromt
616 T	1 Spezialschlüssel 617 für verschiedene Wagentypen 1 dito 618 für verschiedene Wagentypen 1 dito 619 für Opel 1 dito 2567 für Volkswagen 1 dito 2760 für Mercedes	77.—
616 TL	Tafel, leer	13.80



**Spezialschlüssel
für den Öldienst
CHROM-VANADIUM**

617



für Kopfschrauben
7 Schlüsselweiten

Bestell-Nr.	Länge mm	Pack-Norm	Verchromt
617	240	5	10.40



**Spezialschlüssel
für den Öldienst
CHROM-VANADIUM**

618



für Innenvierkant- und Schlitzschrauben
10 Schlüsselweiten

Bestell-Nr.	Länge mm	Pack-Norm	Verchromt
618	230	5	15.40



**Spezialschlüssel
für den Öldienst
CHROM-VANADIUM**

619



für Opel
22 x 32 x 41 mm

Bestell-Nr.	Länge mm	Pack-Norm	Verchromt
619	340	5	12.30



**Ringschlüssel
CHROM-VANADIUM**

625

lang, flach gekröpft,
Köpfe dünnwandig



Metr. Maße

Bestell-Nr. u. Größe	Länge mm	Pack- Norm	Verchromt Köpfe geschliffen
625			
6 x 7	130	10	3.90
8 x 9	150	10	4.40
9 x 11	150	10	4.40
10 x 11	175	10	4.60
11 x 14	200	10	
12 x 13	200	10	4.90
12 x 14	200	10	
13 x 15	210	10	5.20
14 x 15	210	10	
14 x 17	245	10	5.40
16 x 17	245	10	
17 x 19	280	10	5.80
18 x 19	285	10	6.20
19 x 22	330	10	7.—
20 x 22	330	10	
21 x 23	330	5	8.60
22 x 24	330	5	
22 x 27	380	5	9.50
24 x 26	380	5	
24 x 27	380	5	
25 x 28	385	5	9.90
27 x 30	410	5	11.80
27 x 32	410	5	
30 x 32	410	5	
32 x 36	460	1	15.30
36 x 41	525	1	18.90

Amerik. Maße

625 A			
1/4 x 5/16	150	10	4.40
3/8 x 7/16	175	10	4.60
7/16 x 1/2	200	10	4.90
1/2 x 9/16	200	10	
9/16 x 5/8	245	10	5.40
19/32 x 11/16	245	10	
5/8 x 11/16	245	10	
5/8 x 3/4	280	10	5.80
11/16 x 3/4	280	10	
11/16 x 13/16	285	10	6.20
3/4 x 25/32	285	10	
3/4 x 7/8	330	10	7.—
25/32 x 13/16	330	10	
13/16 x 7/8	330	10	
7/8 x 15/16	330	5	8.60
15/16 x 1	380	5	9.50
1 x 1 1/8	385	5	9.90
1 1/16 x 1 1/8	410	5	11.80
1 1/16 x 1 1/4	410	5	
1 3/16 x 1 5/16	410	5	
1 1/4 x 1 3/8	460	1	15.30
1 1/4 x 1 7/16	460	1	
1 5/16 x 1 1/2	460	1	
1 3/8 x 1 1/2	460	1	
1 7/16 x 1 5/8	525	1	18.90



**Ringschlüssel
CHROM-VANADIUM**

625



Engl. Maße

Bestell-Nr. u. Größe	Länge mm	Pack- Norm	Verchromt Köpfe geschliffen
625 W			
1/8 x 3/16	150	10	4.40
3/16 x 1/4	200	10	4.90
1/4 x 5/16	210	10	5.20
5/16 x 3/8	245	10	5.40
3/8 x 7/16	330	10	7.—
7/16 x 1/2	330	5	8.60
1/2 x 9/16	380	5	9.50
1/2 x 5/8	380	5	
9/16 x 5/8	385	5	9.90
9/16 x 11/16	410	5	11.80
5/8 x 3/4	410	5	
11/16 x 3/4	410	5	
11/16 x 13/16	460	1	15.30
3/4 x 7/8	460	1	
7/8 x 1	525	1	18.90



**Ringschlüssel
CHROM-VANADIUM**

625

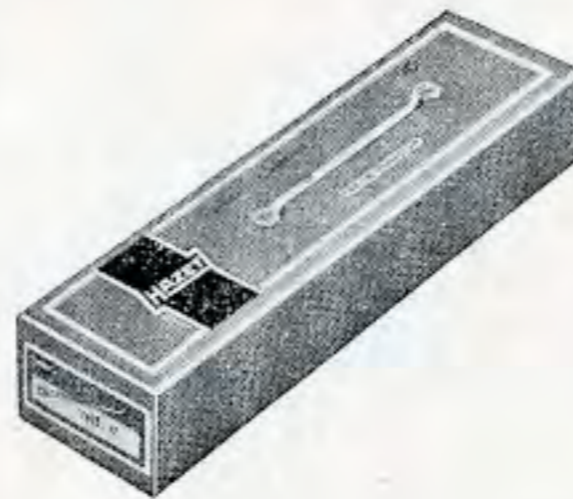

Sätze in hausfarbenen HAZET-Schachteln

Metr. Maße

Bestell-Nr.	Inhalt	Verchromt Köpfe geschliffen
625/6	8 x 9 12 x 13 16 x 17 18 x 19	30.70
625/8	6 x 7 10 x 11 14 x 15 18 x 19 20 x 22	41.60
625/10	6 x 7 10 x 11 14 x 15 18 x 19 21 x 23 24 x 26	59.70
625/10 I	6 x 7 10 x 11 14 x 15 18 x 19 24 x 27 30 x 32	62.90
625/12	6 x 7 10 x 11 14 x 15 18 x 19 21 x 23 25 x 28 27 x 32	81.40



**Ringschlüssel
CHROM-VANADIUM**

625

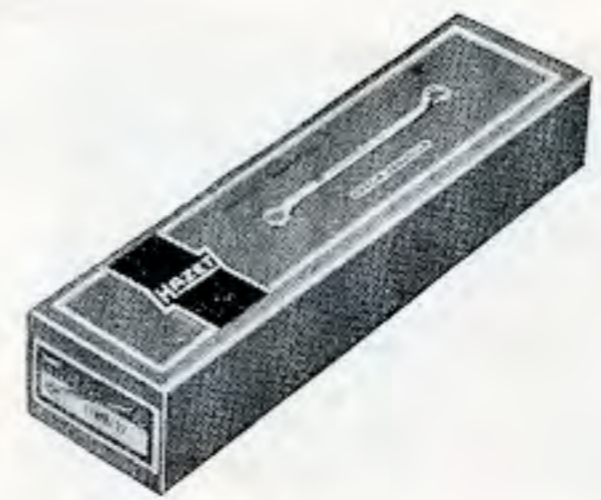

Sätze in hausfarbenen HAZET-Schachteln

Amerik. Maße

Bestell-Nr.	Inhalt	Verchromt Köpfe geschliffen
625/6A	3/8 x 7/16 5/8 x 11/16 13/16 x 7/8 1/2 x 9/16 3/4 x 25/32 15/16 x 1	37.60
625/8A	1/4 x 5/16 1/2 x 9/16 3/4 x 25/32 15/16 x 1 3/8 x 7/16 5/8 x 11/16 13/16 x 7/8 1 1/16 x 1 1/4	53.80

Engl. Maße

625/6W I	1/8 x 3/16 1/4 x 5/16 3/8 x 7/16 3/16 x 1/4 5/16 x 3/8 7/16 x 1/2	35.50
-----------------	--	-------

Sätze auf Reklameständern aus Plastic
(siehe Seite 10)

R 625/8	6 x 7 - 20 x 22	41.60
R 625/12	6 x 7 - 27 x 32	81.40
R 625/8A	1/4 x 5/16 - 1 1/16 x 1 1/4	53.80



**Ringschlüssel
CHROM-VANADIUM**

625



Sätze auf Verkaufstafeln

Metr. Maße

Bestell-Nr.	Inhalt	Verchromt Köpfe geschliffen
VT 625/39	6 x 7 - 16 x 17 je 4 Stück 18 x 19 - 21 x 23 je 3 Stück 24 x 26 - 27 x 32 je 2 Stück	241.40

Amerik. Maße

VT 625/38 A	1/4 x 5/16 - 5/8 x 11/16 je 4 Stück 5/8 x 3/4 - 7/8 x 15/16 je 3 Stück 15/16 x 1 - 1 1/16 x 1 1/4 je 2 Stück	246.40
--------------------	---	--------



Ringschlüssel CHROM-VANADIUM

630

lang, hoch gekröpft

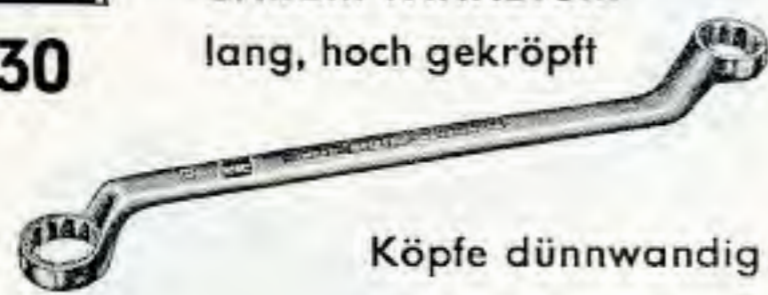

Köpfe dünnwandig

Met. Maße

Bestell-Nr. u. Größe	Länge mm	Pack- Norm	Verchromt Köpfe geschliffen
630			
6 x 7	163	10	4.30
7 x 9	180	10	
8 x 9	180	10	4.60
8 x 10	180	10	
9 x 10	195	10	
9 x 11	195	10	4.80
10 x 11	200	10	
10 x 14	220	10	
11 x 14	220	10	
12 x 13	220	10	5.30
12 x 14	220	10	
13 x 14	220	10	
13 x 15	235	10	
14 x 15	245	10	5.50
13 x 17	245	10	
14 x 17	245	10	6.—
16 x 17	265	10	
17 x 19	275	10	6.60
18 x 19	285	10	
17 x 22	285	10	7.30
19 x 22	305	10	
20 x 22	305	10	7.90
19 x 24	315	5	
21 x 23	315	5	9.40
22 x 24	315	5	
24 x 26	335	5	
22 x 27	340	5	
24 x 27	340	5	10.30
24 x 30	340	5	
25 x 27	350	5	
25 x 28	350	5	11.20
27 x 29	360	5	
27 x 30	360	5	12.40
27 x 32	365	5	
30 x 32	365	5	12.80
30 x 36	400	1	
32 x 36	400	1	16.40
36 x 41	445	1	20.20
Amerik. Maße			
630 A			
1/4 x 5/16	180	10	4.60
3/8 x 7/16	200	10	4.80
7/16 x 1/2	220	10	
1/2 x 9/16	220	10	5.30
9/16 x 5/8	245	10	
19/32 x 11/16	255	10	
5/8 x 11/16	255	10	6.—
5/8 x 3/4	255	10	
11/16 x 3/4	275	10	
3/4 x 25/32	275	10	6.60
11/16 x 13/16	285	10	7.30
3/4 x 7/8	305	10	
25/32 x 13/16	305	10	7.90
13/16 x 7/8	305	10	
7/8 x 15/16	315	5	9.40
15/16 x 1	335	5	10.30
1 x 1 1/8	350	5	11.20
1 1/16 x 1 1/8	360	5	12.40
1 1/16 x 1 1/4	365	5	
1 3/16 x 1 5/16	365	5	12.80
1 1/4 x 1 3/8	400	1	
1 1/4 x 1 5/16	400	1	
1 1/4 x 1 7/16	400	1	16.40
1 5/16 x 1 1/2	400	1	
1 3/8 x 1 1/2	400	1	
1 7/16 x 1 5/8	445	1	20.20



Ringschlüssel CHROM-VANADIUM

630

Engl. Maße

Bestell-Nr. u. Größe	Länge mm	Pack- Norm	Verchromt Köpfe geschliffen
630 W			
1/8 x 3/16	195	10	4.80
3/16 x 1/4	220	10	5.30
1/4 x 5/16	235	10	5.50
5/16 x 3/8	245	10	6.—
3/8 x 7/16	285	10	7.30
7/16 x 1/2	315	5	9.40
1/2 x 9/16	335	5	
1/2 x 5/8	335	5	10.30
9/16 x 5/8	350	5	11.20
9/16 x 11/16	360	5	12.40
5/8 x 3/4	365	5	
11/16 x 3/4	365	5	12.80
11/16 x 13/16	400	1	
3/4 x 7/8	400	1	16.40
7/8 x 1	445	1	20.20

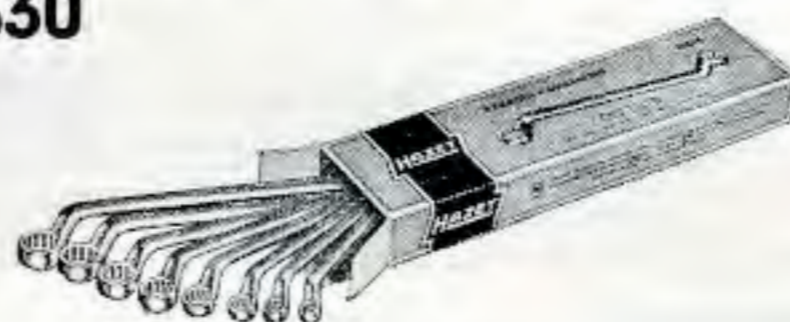

Ringschlüssel CHROM-VANADIUM

630

Sätze in hausfarbenen HAZET-Schachteln

Met. Maße

Bestell-Nr.	Inhalt	Verchromt Köpfe geschliffen
630/6	8 x 9 10 x 11 12 x 13 14 x 15 16 x 17 18 x 19	32.80
630/7	8 x 9 10 x 11 12 x 13 14 x 15 16 x 17 18 x 19 20 x 22	40.70
630/8	6 x 7 8 x 9 10 x 11 12 x 13 14 x 15 16 x 17 18 x 19 20 x 22	45.—
630/10	6 x 7 8 x 9 10 x 11 12 x 13 14 x 15 16 x 17 18 x 19 20 x 22 21 x 23 24 x 26	64.70
630/10 I	6 x 7 8 x 9 10 x 11 12 x 13 14 x 15 16 x 17 18 x 19 20 x 22 24 x 27 30 x 32	68.10
630/12	6 x 7 8 x 9 10 x 11 12 x 13 14 x 15 16 x 17 18 x 19 20 x 22 21 x 23 24 x 26 25 x 28 27 x 32	88.70
630/12N	6 x 7 8 x 9 10 x 11 12 x 13 14 x 15 16 x 17 18 x 19 20 x 22 21 x 23 24 x 26 25 x 27 30 x 32	88.70
630/13	6 x 7 8 x 9 10 x 11 12 x 13 14 x 15 16 x 17 18 x 19 20 x 22 21 x 23 24 x 26 25 x 28 27 x 32 36 x 41	108.90
Amerik. Maße		
630/5A	3/8 x 7/16 1/2 x 9/16 5/8 x 11/16 3/4 x 25/32 13/16 x 7/8	30.60
630/6A	3/8 x 7/16 1/2 x 9/16 5/8 x 11/16 3/4 x 25/32 13/16 x 7/8 15/16 x 1	40.90
630/7A	1/4 x 5/16 3/8 x 7/16 1/2 x 9/16 5/8 x 11/16 3/4 x 25/32 13/16 x 7/8 15/16 x 1	45.50

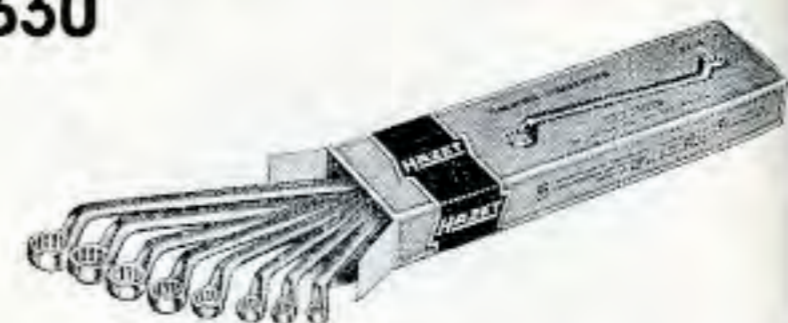

Ringschlüssel CHROM-VANADIUM

630Sätze in hausfarbenen HAZET-Schachteln
Amerik. Maße (Fortsetzung)

Bestell-Nr.	Inhalt	Verchromt Köpfe geschliffen
630/8A	1/4 x 5/16 3/8 x 7/16 1/2 x 9/16 5/8 x 11/16 3/4 x 25/32 13/16 x 7/8 15/16 x 1 11/16 x 1 1/4	58.30
630/12A	1/4 x 5/16 3/8 x 7/16 1/2 x 9/16 19/32 x 11/16 5/8 x 11/16 5/8 x 3/4 3/4 x 7/8 25/32 x 13/16 7/8 x 15/16 15/16 x 1 1 x 1 1/8 1 1/16 x 1 1/4	92.20
Engl. Maße		
630/5W	1/8 x 3/16 1/4 x 5/16 5/16 x 3/8 7/16 x 1/2 9/16 x 5/8	36.90
630/6W I	1/8 x 3/16 3/16 x 1/4 1/4 x 5/16 5/16 x 3/8 3/8 x 7/16 7/16 x 1/2	38.30
630/8W	1/8 x 3/16 3/16 x 1/4 1/4 x 5/16 5/16 x 3/8 3/8 x 7/16 7/16 x 1/2 1/2 x 9/16 9/16 x 5/8	59.80
630/12W	1/8 x 3/16 3/16 x 1/4 1/4 x 5/16 5/16 x 3/8 3/8 x 7/16 7/16 x 1/2 1/2 x 9/16 9/16 x 5/8 5/8 x 3/4 11/16 x 13/16 3/4 x 7/8 7/8 x 1	125.60

Sätze auf Reklameständern aus Plastic
(siehe Seite 10)

R 630/8	6 x 7 - 20 x 22	45.—
R 630/12	6 x 7 - 27 x 32	88.70
R 630/8A	1/4 x 5/16 - 1 1/16 x 1 1/4	58.30
R 630/12A	1/4 x 5/16 - 1 1/16 x 1 1/4	92.20

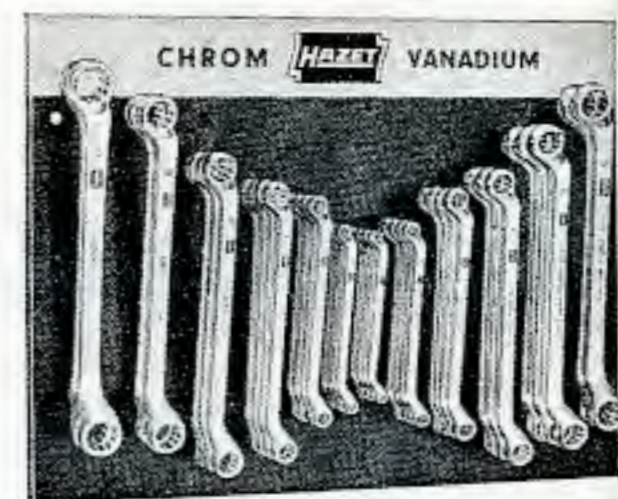

Ringschlüssel CHROM-VANADIUM

630

Sätze auf Verkaufstafeln

Met. Maße

Bestell-Nr.	Inhalt	Verchromt Köpfe geschliffen
VT 630/39	6 x 7 - 16 x 17 je 4 St. 18 x 19 - 21 x 23 je 3 St. 24 x 26 - 27 x 32 je 2 St.	262.30
Amerik. Maße		
VT 630/38A	1/4 x 5/16 - 5/8 x 11/16 je 4 Stück 5/8 x 3/4 - 7/8 x 15/16 je 3 Stück 15/16 x 1 - 1 1/16 x 1 1/4 je 2 Stück	269.—

HAZET Ringschlüssel
CHROM-VANADIUM



Metr. Maße

Bestell-Nr. u. Größe	Länge mm	Pack-Norm	Verchromt Köpfe geschliffen
635 9 x 10	115	10	3.50
12 x 14	140	10	4.30
14 x 15	160	10	4.70
17 x 19	170	10	5.20

Amerik. Maße

Bestell-Nr.	Länge mm	Pack-Norm	Verchromt Köpfe geschliffen
635 A 3/8 x 7/16	115	10	3.50
1/2 x 9/16	140	10	4.30
9/16 x 5/8	160	10	4.70
5/8 x 11/16 5/8 x 3/4	170	10	5.20

Engl. Maße

Bestell-Nr.	Länge mm	Pack-Norm	Verchromt Köpfe geschliffen
635 W 1/8 x 3/16	115	10	3.50
3/16 x 1/4	140	10	4.30
1/4 x 5/16	160	10	4.70
5/16 x 3/8	170	10	5.20
3/8 x 7/16	175	10	5.70

HAZET Ringschlüssel
CHROM-VANADIUM

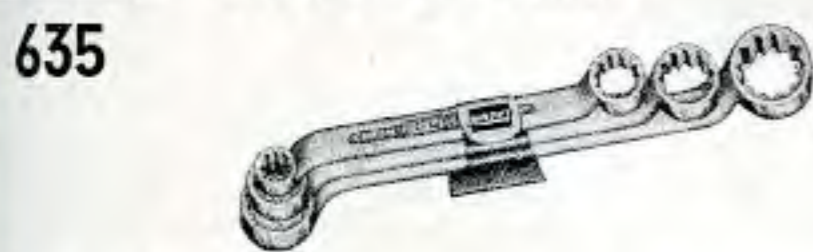

Sätze in Klammern und hausfarbenen HAZET-Schachteln

Metr. Maße

Bestell-Nr.	Inhalt	Verchromt Köpfe geschliffen
635/3	9 x 10 12 x 14 17 x 19	13.—

Amerik. Maße

Bestell-Nr.	Inhalt	Verchromt Köpfe geschliffen
635/3 A	3/8 x 7/16 1/2 x 9/16 5/8 x 11/16	13.—

Engl. Maße

Bestell-Nr.	Inhalt	Verchromt Köpfe geschliffen
635/3 W	1/8 x 3/16 3/16 x 1/4 5/16 x 3/8	13.—

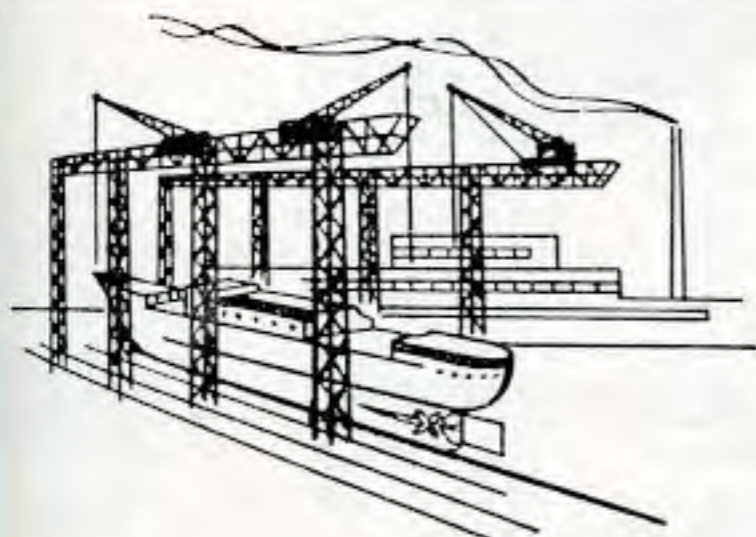

HAZET Ringschlüssel
CHROM-VANADIUM



Metr. Maße

Bestell-Nr. u. Größe	Länge ohne Rohr mm	Rohr-Größe	Rohr-Länge mm	Verchromt
640				ohne Rohr
24	200			19.60
27	200	1	460	22.40
30	210			24.20
32	235			25.80
36	245	2	610	27.80
41	255			28.40
46	260			29.30
50	265	3	760	31.60
55	280			37.90
60	330			42.80
65	350	4	860	46.60
70	350	5	1500	51.50
75	365			56.60
80	375			61.80
85	375			65.40

Amerik. Maße

Bestell-Nr.	Länge ohne Rohr mm	Rohr-Größe	Rohr-Länge mm	Verchromt
640 A				
1	200			19.60
1 1/16	200	1	460	22.40
1 1/8	210			24.20
1 1/4	235			25.80
1 7/16	245	2	610	27.80
1 5/8	255			28.40
1 13/16	260			29.30
2	265	3	760	31.60
2 3/16	280			37.90
2 3/8	330			42.80
2 9/16	350	4	860	46.60
2 3/4	350	5	1500	51.50
2 15/16	365			56.60
3 1/8	375			61.80
3 3/8	375			65.40

Engl. Maße

Bestell-Nr.	Länge ohne Rohr mm	Rohr-Größe	Rohr-Länge mm	Verchromt
640 W				
1/2	200			19.60
9/16	200	1	460	22.40
5/8	210			24.20
11/16	210			24.20
3/4	235			25.80
13/16	245			27.80
7/8	245	2	610	27.80
15/16	255			28.40
1	255			28.40
1 1/8	260	3	760	29.30
1 1/4	265			31.60
1 3/8	280			37.90
1 1/2	330	4	860	42.80
1 5/8	350	5	1500	46.60
1 3/4	350			51.50
2	375			61.80

HAZET Aufsteckrohre



Bestell-Nr.	Rohr-Größe	Rohr-Länge mm	Preis
640-2430	1	460	12.80
3241	2	610	16.—
4655	3	760	17.80
6080	4	860	22.60
6080 Lg.	5	1500	38.80

HAZET Ringschlüssel
CHROM-VANADIUM



Sätze

Metr. Maße Tafelgröße: 960x650 mm

Bestell-Nr.	Inhalt	Verchromt
640/14	32 36 41 46 50 55 60 65 70 75 80 Rohre 610 760 860	496.50
R 640/14	wie vor, mit Aufhängetafel	541.60

Amerik. Maße

Bestell-Nr.	Inhalt	Verchromt
640/14 A	1 1/4 1 7/16 1 5/8 1 13/16 2 2 3/16 2 3/8 2 9/16 2 3/4 2 15/16 3 1/8 Rohre 610 760 860	496.50
R 640/14 A	wie vor, mit Aufhängetafel	541.60

Engl. Maße

Bestell-Nr.	Inhalt	Verchromt
640/14 W	3/4 7/8 15/16 1 1 1/8 1 1/4 1 3/8 1 1/2 1 5/8 1 3/4 2 Rohre 610 760 860	468.30
R 640/14 W	wie vor, mit Aufhängetafel	513.40

HAZET Gelenkschlüssel
CHROM-VANADIUM

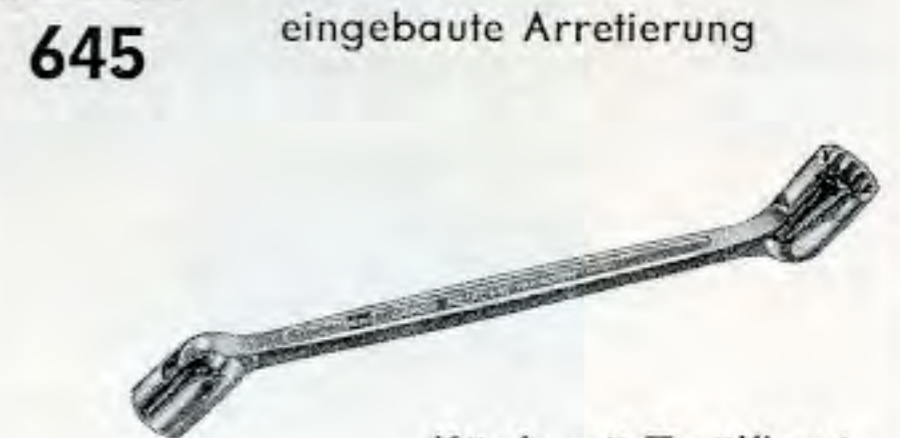

Köpfe mit Zwölfkant

Metr. Maße

Bestell-Nr. u. Größe	Länge mm	Pack-Norm	Verchromt Köpfe Hochglanz
645			
8 x 9	150	10	8.20
10 x 11	175	10	9.—
12 x 13	200	10	10.60
14 x 15	225	10	11.40
16 x 17	250	10	12.50
18 x 19	275	5	12.90
20 x 22	300	5	13.60
21 x 23	325	5	15.60
24 x 27	360	5	18.30

Amerik. Maße

Bestell-Nr.	Länge mm	Pack-Norm	Verchromt Köpfe Hochglanz
645 A			
3/8 x 7/16	150	10	8.20
1/2 x 9/16	200	10	10.60
5/8 x 11/16	250	10	12.50
5/8 x 3/4	275	5	12.90
13/16 x 7/8	300	5	13.60
15/16 x 1	360	5	18.30

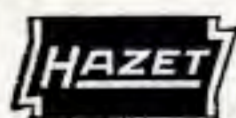

Gelenkschlüssel CHROM-VANADIUM

645

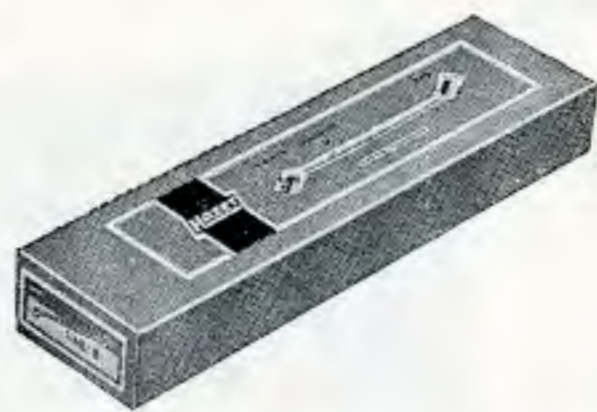

Sätze in hausfarbenen HAZET-Schachteln

Metr. Maße

Bestell-Nr.	Inhalt	Verchromt Köpfe Hochglanz		
645/7	8 x 9 14 x 15 20 x 22	10 x 11 16 x 17 18 x 19	12 x 13 18 x 19 24 x 27	78.20
645/9	8 x 9 14 x 15 20 x 22	10 x 11 16 x 17 21 x 23	12 x 13 18 x 19 24 x 27	112.10

Amerik. Maße

645/6 A	3/8 x 7/16 5/8 x 11/16 13/16 x 7/8	1/2 x 9/16 5/8 x 3/4 15/16 x 1	76.10
---------	--	--------------------------------------	-------



Gelenkschlüssel CHROM-VANADIUM

645

Satz in Plastic-Tasche

Amerik. Maße

645/3 AP	3/8 x 7/16 5/8 x 3/4	1/2 x 9/16	37.40
----------	-------------------------	------------	-------



Gelenkschlüssel CHROM-VANADIUM

645

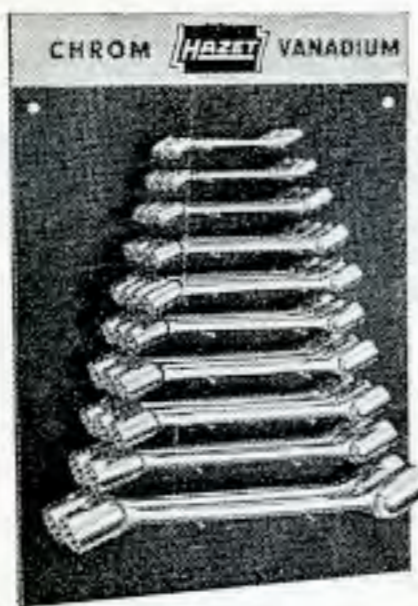

Sätze auf Verkaufstafeln

Metr. Maße

Bestell-Nr.	Inhalt	Verchromt Köpfe Hochglanz		
VT 645/31	8 x 9 14 x 15 18 x 19 24 x 27	10 x 11 16 x 17 21 x 23 22 x 27	je 4 Stück je 3 Stück 2 Stück	369.70

Amerik. Maße

VT 645/20 A	3/8 x 7/16 5/8 x 11/16 5/8 x 3/4 15/16 x 1	1/2 x 9/16 je 4 Stück 13/16 x 7/8 je 3 Stück 2 Stück	241.30
-------------	---	--	--------



Reifenheber CHROM-VANADIUM

650

I - Profil



Bestell-Nr.	Länge		Pack-Norm	Verchromt
	mm	Zoll		
650-6	150	6	10	2.70
8	200	8	10	3.—
12	300	12	10	3.70
16	400	16	5	4.90
20	500	20	5	7.20

652

gebogen



Bestell-Nr.	Länge		Pack-Norm	Preis
	mm	Zoll		
652	600	24	5	10.80

653

für schlauchlose Reifen



653	455	18	5	9.20
-----	-----	----	---	------



Kreuzschlüssel VERGÜTUNGSSTAHL

705

„Popular“ für Pkw



Bestell-Nr.	mm/Zoll	Pack-Norm	Silbergr. lackiert
705	17 x 19 x 20,64 x 22	25	9.50
705-19	19 x 19 x 19 x 19	25	9.50
705-1719	17 x 17 x 19 x 19	25	9.50
705 A	5/8 x 3/4 x 13/16 x 7/8	25	9.50
705 W	5/16 x 3/8 x 7/16 x 1/2	25	9.50



Kreuzschlüssel VERGÜTUNGSSTAHL

705 V

„Popular“ für Pkw

Bestell-Nr.	mm/Zoll	Pack-Norm	Verchromt Köpfe geschliffen
705 V	17 x 19 x 20,64 x 22	25	12.30
705 AV	5/8 x 3/4 x 13/16 x 7/8	25	12.30



Kreuzschlüssel CHROM-VANADIUM

720

für Lkw

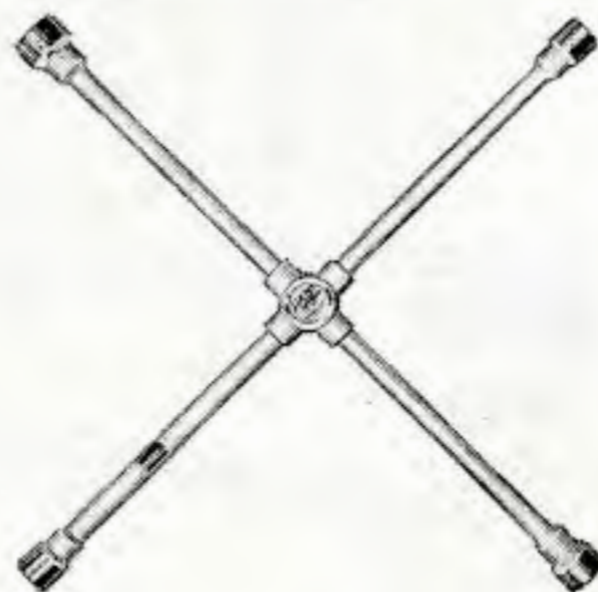

Bestell-Nr.	mm/Zoll	Pack-Norm	Verchr. Köpfe geschl.
720	24 x 27 x 32 x 38	5	56.—
720-30	24 x 27 x 30 x 32	5	56.—
720 A	15/16 x 1 1/16 x 1 1/4 x 1 1/2	5	56.—



Flachmeißel CHROM-VANADIUM

730

731



Bestell-Nr.	mm	Pack-Norm	Pre
730-1	100 x 15 x 14 x 9	10	3.—
2	125 x 18 x 14 x 9	10	3.—
3	150 x 18 x 17 x 11	10	3.—
4	150 x 20 x 20 x 12	10	4.—
5	175 x 22 x 20 x 12	10	5.—
6	200 x 24 x 23 x 13	10	6.—
7	250 x 26 x 23 x 13	10	7.—

731-1	120 x 10 x 10	10	2.5
2	130 x 11 x 10	10	2.7
3	130 x 12 x 12	10	3.1
4	140 x 14 x 12	10	3.2
5	150 x 15 x 12	10	3.7
6	150 x 16 x 12	10	3.7
7	160 x 18 x 14	10	4.5
8	180 x 20 x 16	10	5.—
9	200 x 22 x 16	10	5.3



Kreuzmeißel CHROM-VANADIUM

740

741



740-1	100 x 6 x 14 x 9	10	3.—
2	125 x 7 x 14 x 9	10	3.2
3	150 x 8 x 17 x 11	10	3.5
4	150 x 8 x 20 x 12	10	4.3
5	175 x 9 x 20 x 12	10	5.1
6	200 x 10 x 23 x 13	10	6.1
7	250 x 12 x 23 x 13	10	7.2

741-1	130 x 4 x 10	10	2.7
2	130 x 5 x 12	10	3.1
3	140 x 6 x 12	10	3.3
4	150 x 7 x 12	10	3.6
5	160 x 8 x 14	10	4.4
6	180 x 9 x 16	10	5.3
7	200 x 10 x 16	10	6.—



Durchschläger, Körner Splintentreiber CHROM-VANADIUM

745-

748



745-1	120 x 1 x 10	10	
2	120 x 2 x 10	10	
3	120 x 3 x 10	10	
4	120 x 4 x 10	10	2.5
5	120 x 5 x 10	10	
6	120 x 6 x 10	10	
7	120 x 7 x 10	10	
8	120 x 8 x 10	10	
9	120 x 1 x 12	10	
10	120 x 2 x 12	10	
11	120 x 3 x 12	10	
12	120 x 4 x 12	10	
13	120 x 5 x 12	10	
14	120 x 6 x 12	10	3.—
15	120 x 7 x 12	10	
16	120 x 8 x 12	10	
17	120 x 9 x 12	10	
18	120 x 10 x 12	10	
19	150 x 4 x 12	10	3.50

746-1	120 x 10	10	2.10
2	120 x 12	10	2.90

748-1	115 x 2 x 8	10	3.20
2	125 x 3 x 8	10	3.50
3	150 x 2,5 x 10	10	
4	150 x 3 x 10	10	
5	150 x 4 x 10	10	
6	150 x 5 x 10	10	3.60
7	150 x 6 x 10	10	
8	150 x 8 x 10	10	
9	160 x 5 x 10	10	3.70
10	180 x 6 x 12	10	4.60
11	200 x 8 x 12	10	4.80



Meißel, Durchschläger, Körner und Splintentreiber

750-751

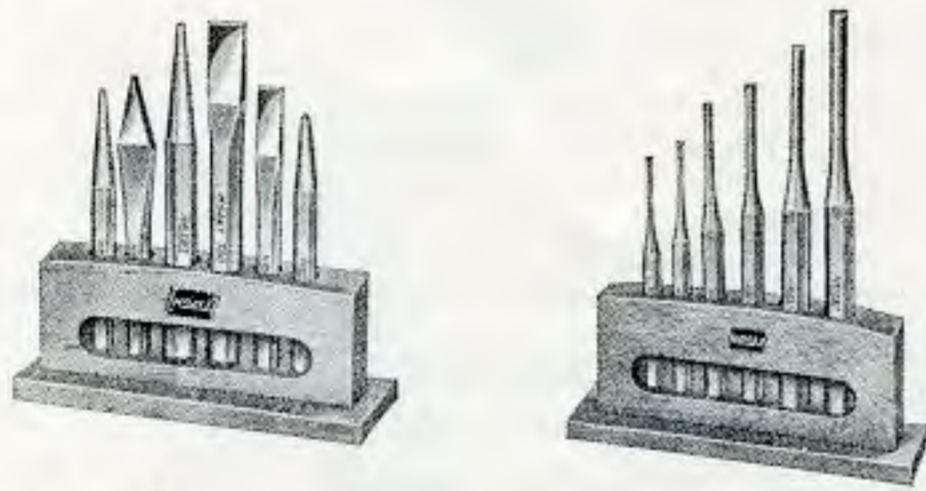

Sätze auf Ständer

Bestell-Nr.	Inhalt			Preis
750/6	731 - 2 745 - 3	731 - 5 745 - 19	741 - 1 746 - 1	17.20
750/6 I	730 - 3 745 - 2	730 - 6 745 - 12	740 - 3 746 - 2	21.50
751/6	748 - 1, - 2, - 5, - 9, - 10, - 11			23.40
751/6 I	748 - 3, - 4, - 5, - 6, - 7, - 8			21.60



Parallel spannende Gripzangen
mit gehärteten **geraden** Stahlbacken, mit Auslösehebel
Einstellbereich von 0 - 50 mm

754



Bestell-Nr.	Länge		Pack-Norm	Glanzvernickelt
	mm	Zoll		
754	250	10	1	21.—



mit Einhandbedienung

754 E

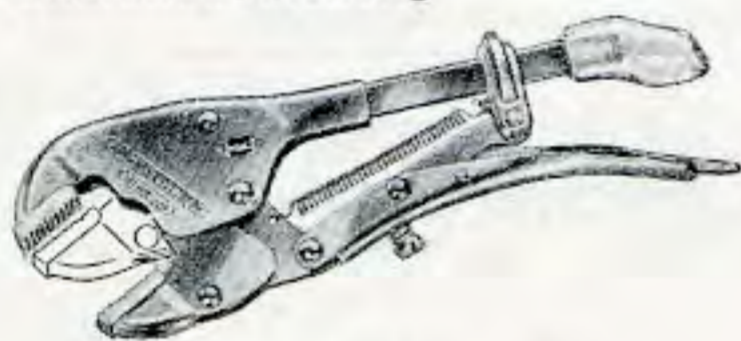

mit Stellschraube zur Veränderung des Normal-Spanndruckes

754 E	280	11	1	24.—
-------	-----	----	---	------



Gripzangen
CHROM-VANADIUM
mit geschmiedeten Backen - eine Backe **gerade**,
eine Backe **halbrund** - mit Auslösehebel
kräftige Werkstattausführung

755

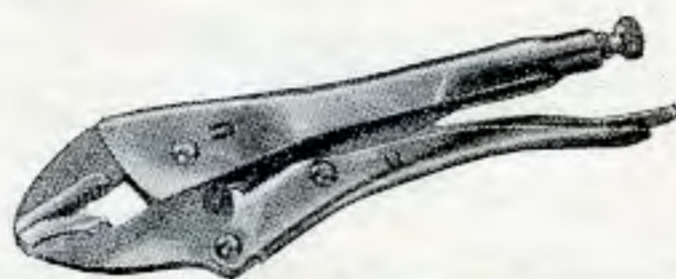

755 - 7	180	7	1	10.80
755 - 10	250	10	1	12.30



mit Einhandbedienung

755 E

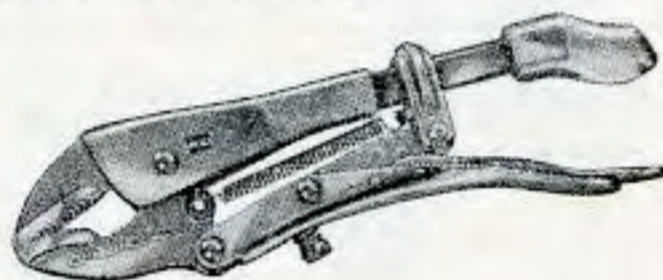

mit Stellschraube zur Veränderung des Normal-Spanndruckes

755 E	250	10	1	19.40
-------	-----	----	---	-------



Universal-Gripzange
CHROM-VANADIUM
mit **geraden** Backen

756



Bestell-Nr.	Länge		Pack-Norm	Glanzvernickelt
	mm	Zoll		
756	165	6 1/2	1	9.70



Universal-Gripzangen
CHROM-VANADIUM
mit geschmiedeten **halbrunden** Backen,
Drahtschneider, mit Auslösehebel
kräftige Werkstattausführung

757



757 - 7	180	7	1	10.80
10	250	10	1	12.30



mit kombinierter Maulform
für **Rund-** und **Flach-**Profile

757



757 - 12	300	12	1	18.80
----------	-----	----	---	-------



mit Einhandbedienung
beide Backen **halbrund**

757 E

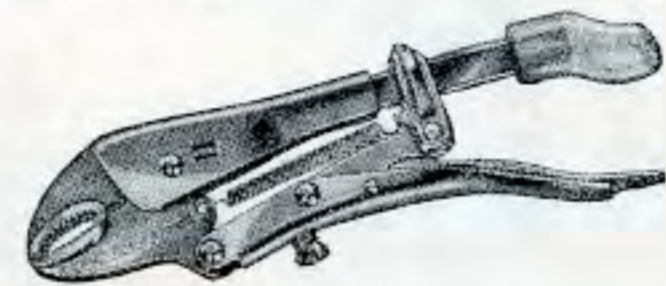

mit Stellschraube zur Veränderung des Normal-Spanndruckes

757 E - 10	250	10	1	19.40
------------	-----	----	---	-------



Schweißer-Gripzange
CHROM-VANADIUM
mit Auslösehebel

758-1



758 - 1	280	11	1	18.20
---------	-----	----	---	-------



Gripzange
CHROM-VANADIUM
für sperrige Werkstücke, mit Auslösehebel

758-2

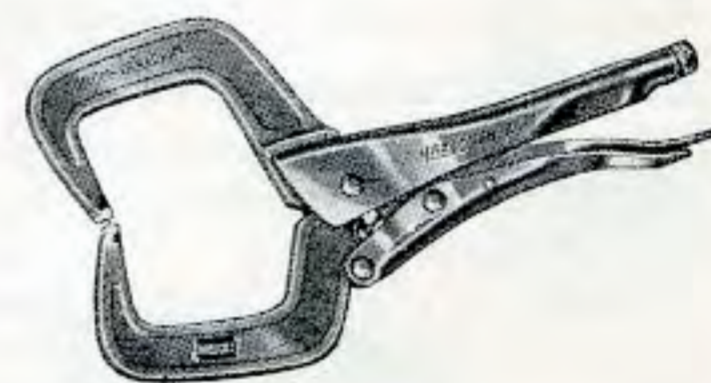

758 - 2	280	11	1	18.20
---------	-----	----	---	-------



Schnellspann-Universalzange
CHROM-VANADIUM
mit durchgestecktem Gewerbe und Brennerloch

759



Bestell-Nr.	Länge		Pack-Norm	Hochglanz verchromt
	mm	Zoll		
759	250	10	1	18.—



Universalzangen
CHROM-VANADIUM

760



Bestell-Nr.	Länge		Pack-Norm	Hochglanz verchromt	Verchromt
	mm	Zoll			
760-1	115	4 1/2	1	6.30	—
3	240	9 1/2	1	10.90	7.90
4	375	15	1	24.60	19.30

mit Handschutz-Isolierung 10000 V

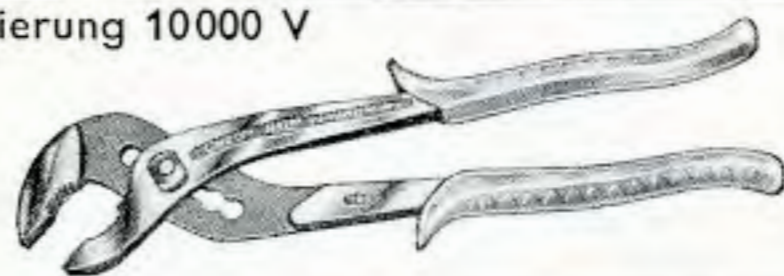

760-11	115	4 1/2	1	8.40	—
33	240	9 1/2	1	14.20	11.20
44	375	15	1	28.50	23.30

R 760	Reklameständer mit 3 Stück 9 1/2"			32.70	23.70
R 760 I	dito, isoliert			42.60	33.60



Universalzange
CHROM-VANADIUM
mit 5 Führungsrillen

760N

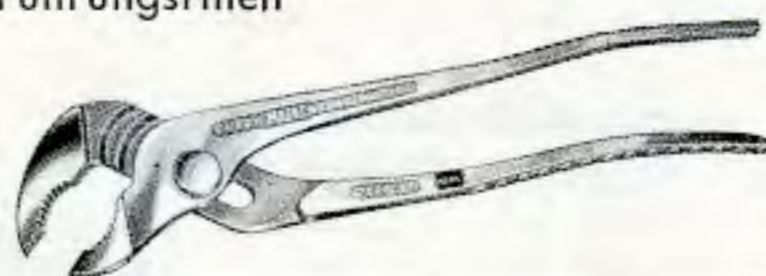

Bestell-Nr.	Länge		Pack-Norm	Hochglanz verchromt
	mm	Zoll		
760 N	240	9 1/2	1	13.60



Zündkerzenschlüssel
CHROM-VANADIUM
doppelseitig, mit umlegbarem Griff

761



Bestell-Nr.	Länge mm	Schlüsselweite mm/Zoll	Pack-Norm	Verchromt Köpfe geschliffen
761 A	220	13/16 x 1	1	5.30



Zündkerzenschlüssel
mit Kardangeln, für schwer zugängliche Kerzen

762



762	240	21 (13/16)	1	13.50
-----	-----	------------	---	-------



Zündkerzenschlüssel
besonders lang, für tiefliegende Kerzen, insbesondere für Porsche

763

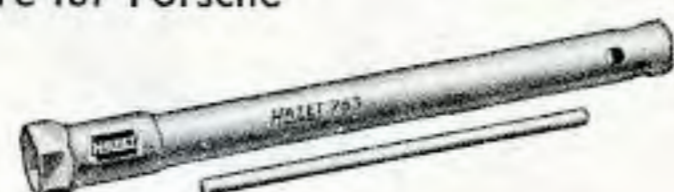

763	240	21 (13/16)	1	9.80
-----	-----	------------	---	------



Zündkerzenschlüssel
mit Kugelkopf

764



insbesondere für Volkswagen

Bestell-Nr.	Länge mm	Schlüsselweite mm/Zoll	Pack-Norm	Verchromt Köpfe geschliffen
764	230	21 (13/16)	1	10.30



Zündkerzenschlüssel
CHROM-VANADIUM
mit Kugelgelenk, für fast sämtliche Wagentypen und Motoren mit schwer zugänglichen Kerzen

765



765	295	21 u. 26	1	17.50
-----	-----	----------	---	-------



Zündkerzenschlüssel
für Motorrad und Motorroller

766



766	160	21 (13/16)	1	3.90
-----	-----	------------	---	------



Zündkerzenschlüssel
mit Kugelgelenk, insbesondere für Mercedes

767



767	190	21 (13/16)	1	8.60
-----	-----	------------	---	------

Zündkerzenschlüssel
spez. für Volkswagen siehe Seite 54



Radmutternschlüssel
CHROM-VANADIUM
Pkw

768



768-17	265	17	1	10.30
19	265	19 (3/4)	1	10.30



Radmutternschlüssel
CHROM-VANADIUM
Lkw

769

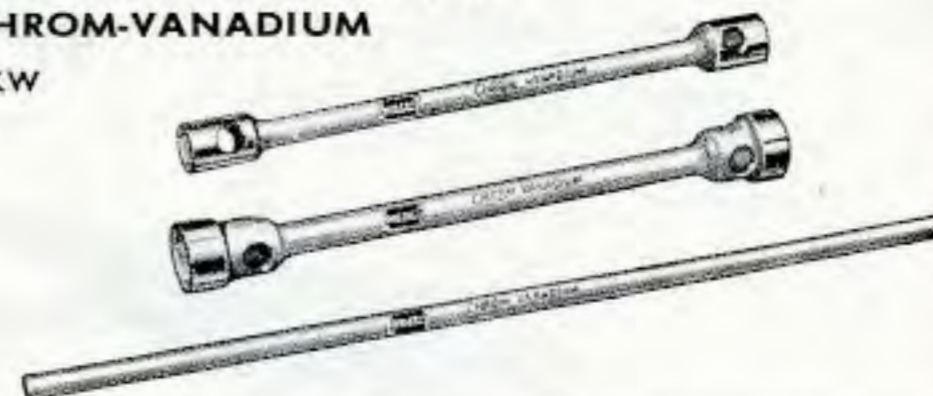

769-1	406	24 x 27	3	14.20
2	406	28 x 33 (5/8 x 3/4 W)	3	16.—
3	410	32 x 38	3	18.—
769-1 A	406	15/16 x 1 1/16	3	14.20
3 A	410	1 1/4 x 1 1/2	3	18.—
769-4	630	Stecker 18 ø	5	8.30



Radschraubenkurbel
CHROM-VANADIUM

772



mit Stift für gelochte Zierkappen

772	200	19 (3/4)	5	10.40
-----	-----	----------	---	-------



Universal-Radabzieher
CHROM-VANADIUM
Zugarme verschieb- und auswechselbar

781



Lochkreisdurchmesser:
Minimum/Maximum
90-200 mm

Bestell-Nr.		Pack-Norm	Verchromt
781-3	mit 3 Zugarmen	1	89.—
5	mit 5 Zugarmen	1	109.80
781-7	loser Zugarm	1	10.30
9	loser Schlaggriff	1	8.60



Radabzieher
SPEZIALSTAHL
2- und 3-armig, umschwenkbar,
als Innen- und Außen-Abzieher zu verwenden

782-783



Bestell-Nr.		Spannweite mm	Spanntiefe mm	Pack-Norm	Silbergrau lackiert
782-15	zweiarmig	150	80	1	35.60
20		200	130	1	61.60
783-15	dreiarmlig	150	80	1	52.40
20		200	130	1	81.—



Radabzieher
SPEZIALSTAHL
2- und 3-armig, besonders stark,
in Höhe und Tiefe verstellbar

784-785

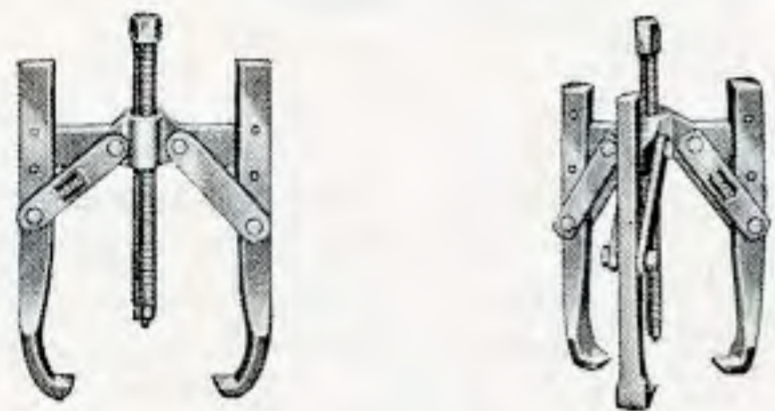

Bestell-Nr.		Spannweite mm	Pack-Norm	Silbergrau lackiert
784	zweiarmig	300	1	80.30
785	dreiarmlig	300	1	117.50



Dreiarmlige Abzieher
SPEZIALSTAHL
als Innen- und Außen-Abzieher zu verwenden

786



Bestell-Nr.	Spannweite mm	Spanntiefe mm	Pack-Norm	Silbergrau lackiert
786-1	120	80	1	51.90
2	160	115	1	81.80
3	225	170	1	115.—



Zweiarmige Universal-Radabzieher
SPEZIALSTAHL

787

durch Auswechseln
der Zugarme als
Innen- und Außen-Abzieher
zu verwenden

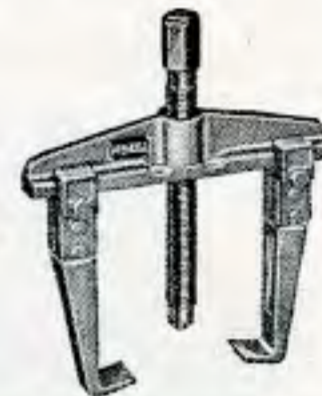

Bestell-Nr.	Spannweite mm	Spanntiefe mm	Pack-Norm	Silbergrau lackiert
787-10	80	90	1	41.10
15	130	90	1	44.20
20	160	150	1	70.60
25	220	150	1	78.90
30	250	200	1	124.—
35	370	200	1	148.50
40	550	225	1	171.60

Lose Abzughaken



mit normalen Gleitschuhen

Bestell-Nr.	Länge mm	für Abzieher Nr.	Pack-Norm	Preis per Paar
787-1015	90	787-10 u. 15	1	23.50
2025	150	20 u. 25	1	39.30
3035	200	30 u. 35	1	54.90
4000	225	40	1	64.80

mit extra langen Gleitschuhen

Bestell-Nr.	Länge mm	für Abzieher Nr.	Pack-Norm	Preis per Paar
787-1015 Lg.	190	787-10 u. 15	1	29.50
2025 Lg.	300	20 u. 25	1	49.40
3035 Lg.	300	30 u. 35	1	74.20
3035/4 Lg.	400	30 u. 35	1	82.90
3035/5 Lg.	500	30 u. 35	1	90.80
4000 Lg.	300	40	1	79.20
4000/4 Lg.	400	40	1	87.80
4000/5 Lg.	500	40	1	97.70



Innen-Auszieher
SPEZIALSTAHL

788



Bestell-Nr.	Spannweite mm	Pack-Norm	Blank poliert
788-1	12-17	1	17.80
2	16-21	1	22.40
3	20-28	1	26.60
4	27-37	1	29.70
5	35-47	1	36.90
6	45-58	1	43.10
7	56-70	1	56.—
8	70-100	1	85.60

Gegenstütz-Vorrichtung

Bestell-Nr.	für Auszieher	Pack-Norm	Silbergrau lackiert
788-10	788-1, 2 und 3	1	24.—
20	4, 5, 6 und 7	1	35.—
30	8	1	69.30

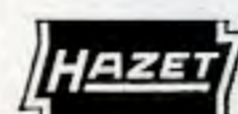

Lenkradabzieher
SPEZIALSTAHL
für alle Lenksäulen
32-57 mm ø

789



789	mit 5 auswechselbaren Einlegerringen für verschieden starke Lenksäulen	1	58.50
-----	--	---	-------



Kolbenringzangen

790

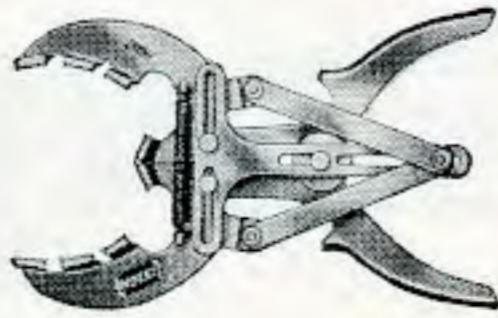

Bestell-Nr.	für Kolbenringe mm \varnothing	Pack- Norm	Glanzvernickelt
790 - 1	50 - 100	1	10.30
1a	65 - 110	1	11.—
2	110 - 150	1	13.90



Ventilkeilpistole

zusammen mit HAZET 792 zu verwenden

791



Bestell-Nr.	Länge mm	Pack- Norm	Glanzvernickelt
791	195	1	8.40



Ventilfeder-Spannapparate

zusammen mit HAZET 791 zu verwenden

792



Bestell-Nr.		Länge mm	Pack- Norm	Glanzvernickelt
792 - 1	leicht	290	1	26.60
2	schwer	380	1	45.50

Ersatzbacken

Bestell-Nr.	für	Pack- Norm	Preis per Paar
792 - 1 E	792 - 1	1	5.90
2 E	792 - 2	1	5.90



Ventilfeder-Hebezangen

für untengesteuerte Ventile

793



mit verstellbaren
Backen

mit Handrad für
automatische Feststellung

Bestell-Nr.	Länge mm	Pack- Norm	Glanzvernickelt
793 - 1	250	1	18.20
2	200	1	18.90



Kolbenring-Spannbänder mit Sperrklinke und Spanschlüssel

794

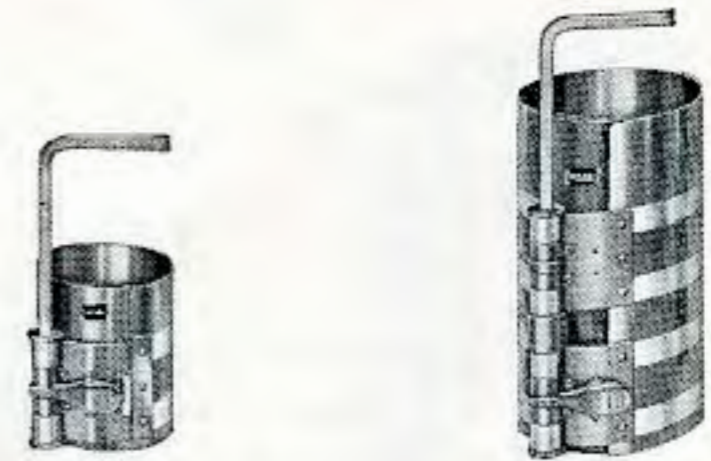

Bestell-Nr.	für Kolbenringe		Höhe		Pack- Norm	Preis
	mm	Zoll	mm	Zoll		
794 - 01	40 - 75	1 1/2 - 3	50	2	1	6.—
1	60 - 125	2 1/8 - 5	80	3	1	10.90
2	90 - 175	3 1/2 - 7	80	3	1	12.40
3	90 - 175	3 1/2 - 7	165	6 1/2	1	24.—



Ventileinschleifer

mit Saugnapf

795



Bestell-Nr.	Länge mm	Saugfläche mm	Pack- Norm	Preis
795 - 1	275	20	5	2.50
2	275	25	5	3.—
3	275	30	5	3.20
4	275	37	5	3.50



Bremsefederzange

CHROM-VANADIUM

796



für aufgenietete Bremsbeläge

Bestell-Nr.	Länge		Pack- Norm	Verchromt
	mm	Zoll		
796	215	8 1/2	1	9.20



Bremsefederzange

CHROM-VANADIUM

mit beweglichem Teller

797



für aufgenietete und aufgeklebte Bremsbeläge

Bestell-Nr.	Länge		Pack- Norm	Verchromt
	mm	Zoll		
797	340	13 1/2	1	14.80



Schlauchklemmenzangen CHROM-VANADIUM

798



drehbare Backen

Bestell-Nr.	Länge		Pack-Norm	Verchromt
	mm	Zoll		
798	205	8	1	15.90

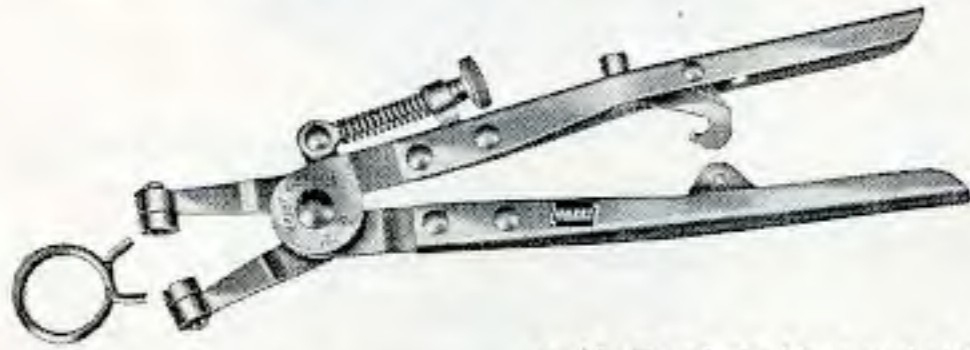

mit Feststellvorrichtung

einstellbare Maulöffnung für verschieden große Schlauchklemmen

798 - 1	280	11	1	20.40
2	415	16 1/2	1	21.80



Türfederzange

zum Entfernen und Einsetzen von Federn der Türgriffe und Fensterkurbeln an VW 1500, Opel, Ford, BMW usw.

799



799	210	8	1	8.60
-----	-----	---	---	------



Batteriedienst-Behälter aus säurefestem Gummi

802

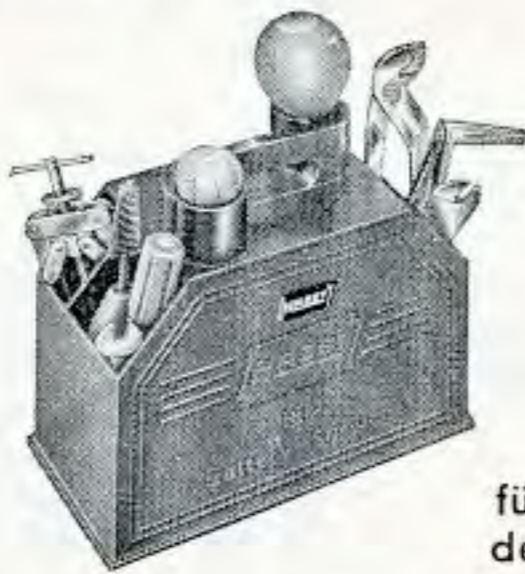

für ca. 4 Liter
destilliertes Wasser

Bestell-Nr.	Inhalt	Preis
802	Gabelschlüssel 450/10 x 14, Universalzange 760-3, Schraubendreher 811-3, Batteriezeuge 1848, Batteriefüller 8020, Säureprüfer 8021, Polklemmenabzieher 8022, Polklemmenzange 8023, Pol- und Klemmen-Reinigungsbürste 8024	130.—
802 L	Behälter, leer	52.60

Batteriedienst-Werkzeuge

Bestell-Nr.	Bezeichnung	Pack-Norm	Preis
8020	Batteriefüller 	1	6.20
8021	Säureprüfer mit Aräometer 	1	7.80
8022	Polklemmenabzieher 	1	15.—
8023	Polklemmenzange 7 1/2" 	1	18.40
8024	Pol- und Klemmen-Reinigungsbürste 	1	3.60
8025-1	Batteriezellenprüfer mit 1 abschaltbaren Widerstand 	1	36.20
2	mit 2 abschaltbaren Widerständen	1	42.70



Werkzeugausrüstungen CHROM-VANADIUM

804

in fünfteiligen, stabilen Werkzeugkästen, verschließbar

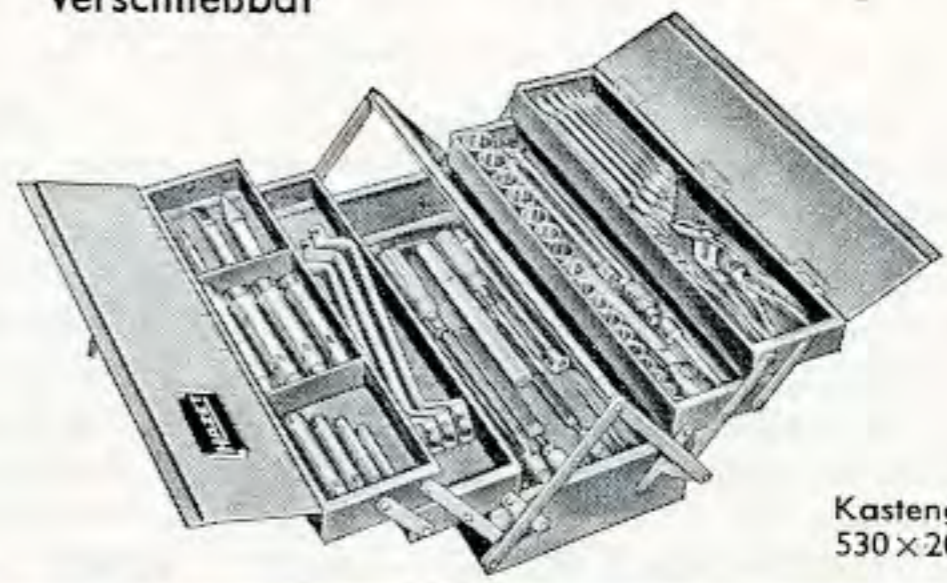

Kastengröße:
530 x 200 x 200 mm

Bestell-Nr.	Sortimente einschl. Werkzeugkasten	Gewicht kg	Verchromt
804 - 1	Metr. 84 teilig	25	574.—
804 - 1 A	Amer. 76 teilig	21	439.—
804 - 1 W	Engl. 65 teilig	18	395.—
804 - 2	Metr. 60 teilig	18,5	350.—
804 - 2 A	Amer. 57 teilig	18	343.—
804 - 2 W	Engl. 49 teilig	16	318.—
804 - 4	Metr. 56 teilig	20	392.—
804 - 4 A	Amer. 52 teilig	18	341.—
804 - 4 W	Engl. 41 teilig	16	290.—
804 L	Werkzeugkasten, leer	8	46.80

INHALTSÜBERSICHT

Nr.	Bezeichnung	Metr. 84teilig HAZET 804-1	Amer. 76teilig HAZET 804-1A	Engl. 65teilig HAZET 804-1W
430	Steckschlüssel, massiv	8 x 9 10 x 11 12 x 13 14 x 15 16 x 17 18 x 19 20 x 22 21 x 23 24 x 26 25 x 28 27 x 29 30 x 32	—	—
433	Drehstift	0619	—	—
433	Drehstift	2032	—	—
450	Gabelschlüssel	6 x 7 8 x 9 10 x 11 12 x 13 14 x 15 16 x 17 18 x 19 20 x 22 21 x 23 24 x 26 25 x 28 27 x 32	1/4 x 5/16 5/16 x 3/8 5/16 x 13/32 3/8 x 7/16 1/2 x 9/16 9/16 x 5/8 19/32 x 11/16 5/8 x 3/4 25/32 x 13/16 7/8 x 15/16 15/16 x 1 1 x 1 1/8	1/16 x 3/32 3/32 x 1/8 1/8 x 3/16 3/16 x 1/4 1/4 x 5/16 5/16 x 3/8 3/8 x 7/16 7/16 x 1/2 1/2 x 9/16 9/16 x 5/8 5/8 x 3/4
605	Gabel-Ringschlüssel, kurz	—	1/4 5/16 3/8 7/16 1/2 9/16 5/8 11/16 3/4	1/8 1 BA 0 BA 3/16 1/4 5/16 3/8 7/16 1/2
630	Ringschlüssel, gekröpft	6 x 7 8 x 9 10 x 11 12 x 13 14 x 15 16 x 17 18 x 19 20 x 22 21 x 23 24 x 26 25 x 28 27 x 32 36 x 41	1/4 x 5/16 3/8 x 7/16 1/2 x 9/16 19/32 x 11/16 5/8 x 11/16 3/4 x 25/32 13/16 x 7/8 15/16 x 1 1 x 1 1/8 11/16 x 1 1/4	1/8 x 3/16 3/16 x 1/4 1/4 x 5/16 5/16 x 3/8 3/8 x 7/16 7/16 x 1/2 1/2 x 9/16 9/16 x 5/8
900 Z	Zwölfkant-Einsätze 1/2" □ Antrieb	12 13 14 15 16 17 18 19 20 21 22 23 24 26 27 28 30 32	3/8 7/16 1/2 9/16 19/32 5/8 11/16 3/4 25/32 13/16 7/8 15/16 31/32 1 1 1/16 1 1/8 13/16 1 1/4	3/16 1/4 5/16 3/8 7/16 1/2 9/16 5/8 11/16 3/4
2140	Hammer	300 g	—	—
2141	Engl. Hammer	—	3/4 lbs.	3/4 lbs.

Fortsetzung nächste Seite



Werkzeugausrüstung
CHROM-VANADIUM

804

INHALTSÜBERSICHT (Fortsetzung)

ALLE SORTIMENTE (804-1 - 804-1A - 804-1W) enthalten außerdem:

650-12	Reifenheber 12", 2 Stück	915	T-Griff 12"
650-20	dito 20", 2 Stück	916	Umschaltknarre 12"
730-3	Flachmeißel 150 x 18	917	Verlängerung 5"
740-3	Kreuzmeißel 150 x 8	918	Verlängerung 10"
745-10	Durchschläger 120 x 2	920	Universalgelenk
746-2	Körner 120 x 12	980-13	Schraubendreher-Einsatz 13 x 2
760-3	Universalzange 9 1/2"	1801-2	Seitenschneider 6 1/2"
768-19	Radmutternschl. Pkw	1850-3	Kombizange 7"
811-6	Schraubendreher 125 x 7	2120-8	Rundfeile 8"
811-13	dito 200 x 10	2122-8	Flachfeile 8"
813-3	dito 100 x 3,5	2123-8	Dreikantfeile 8"
	Betätigungswerkzeuge 1/2" □ Antrieb	2154	Bandmaß 2 m
911	Schwunggriff 16 1/2"		



Werkzeugausrüstung
CHROM-VANADIUM

804

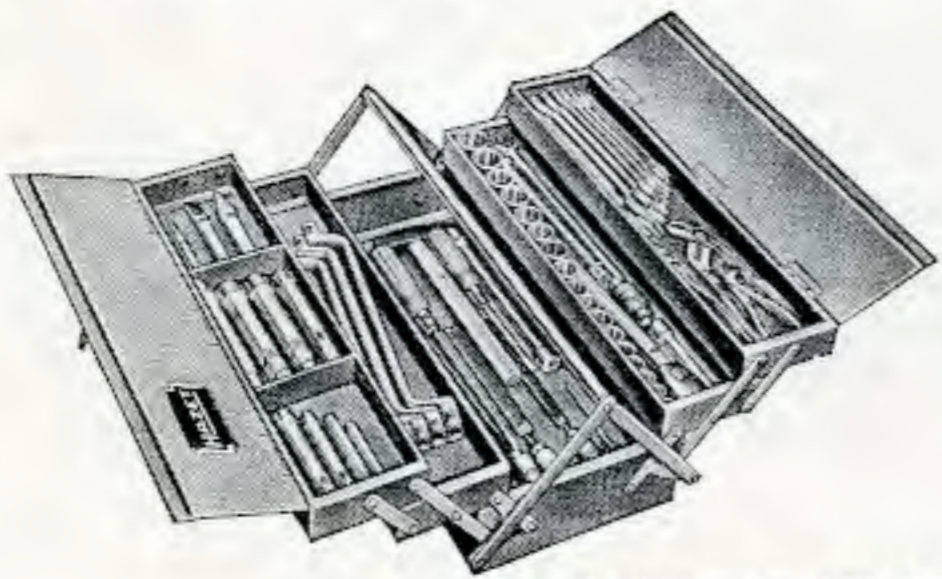

Kastengröße: 530 x 200 x 200 mm

INHALTSÜBERSICHT

Nr.	Bezeichnung	Metr. 60 teilig HAZET 804-2	Amer. 57 teilig HAZET 804-2A	Engl. 49 teilig HAZET 804-2W
450	Gabelschlüsselsatz im „Remscheid“-Klemmhalter	6 x 7	1/4 x 5/16	1/16 x 3/32
		8 x 9	5/16 x 13/32	3/32 x 1/8
		10 x 11	3/8 x 7/16	1/8 x 3/16
		12 x 13	1/2 x 9/16	3/16 x 1/4
		14 x 15	19/32 x 11/16	1/4 x 5/16
		16 x 17	5/8 x 3/4	5/16 x 3/8
		18 x 19	25/32 x 7/8	3/8 x 7/16
		20 x 22	15/16 x 1	7/16 x 1/2
		24 x 26		
		27 x 32		
		630	Ringschlüssel, gekröpft	6 x 7
8 x 9	3/8 x 7/16			3/16 x 1/4
10 x 11	1/2 x 9/16			1/4 x 5/16
12 x 13	19/32 x 11/16			5/16 x 3/8
14 x 15	5/8 x 11/16			3/8 x 7/16
16 x 17	3/4 x 25/32			7/16 x 1/2
18 x 19	13/16 x 7/8			1/2 x 9/16
20 x 22	15/16 x 1			9/16 x 5/8
900 Z	Zwölfkant-Einsätze 1/2" □ Antrieb	10 12 13	3/8 7/16 1/2	3/16 1/4 5/16
		14 15 16	9/16 19/32 5/8	3/8 7/16 1/2
		17 18 19	11/16 3/4 25/32	9/16 5/8 11/16
		20 21 22	13/16 7/8 15/16	3/4
		23 24 26	31/32 1 11/16	
		27 28 30	11/8 13/16 11/4	
		32		
		2140	Hammer	300 g
2141	Engl. Hammer	—	3/4 lbs.	3/4 lbs.

ALLE SORTIMENTE (804-2 - 804-2A - 804-2W) enthalten außerdem:

650-12	Reifenheber 12", 2 Stück	915	T-Griff 12"
650-20	dito 20", 2 Stück	916	Umschaltknarre 12"
730-3	Flachmeißel 150 x 18	917	Verlängerung 5"
740-3	Kreuzmeißel 150 x 8	918	Verlängerung 10"
745-10	Durchschläger 120 x 2	920	Universalgelenk
760-3	Universalzange 9 1/2"	980-13	Schraubendreher-Einsatz 13 x 2
811-6	Schraubendreher 125 x 7	1850-3	Kombizange 7"
811-13	dito 200 x 10	2120-8	Rundfeile 8"
813-3	dito 100 x 3,5	2122-8	Flachfeile 8"
	Betätigungswerkzeuge 1/2" □ Antrieb	2123-8	Dreikantfeile 8"
911	Schwunggriff 16 1/2"		

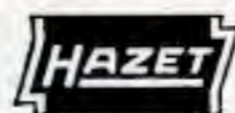

Werkzeugausrüstung
CHROM-VANADIUM

804

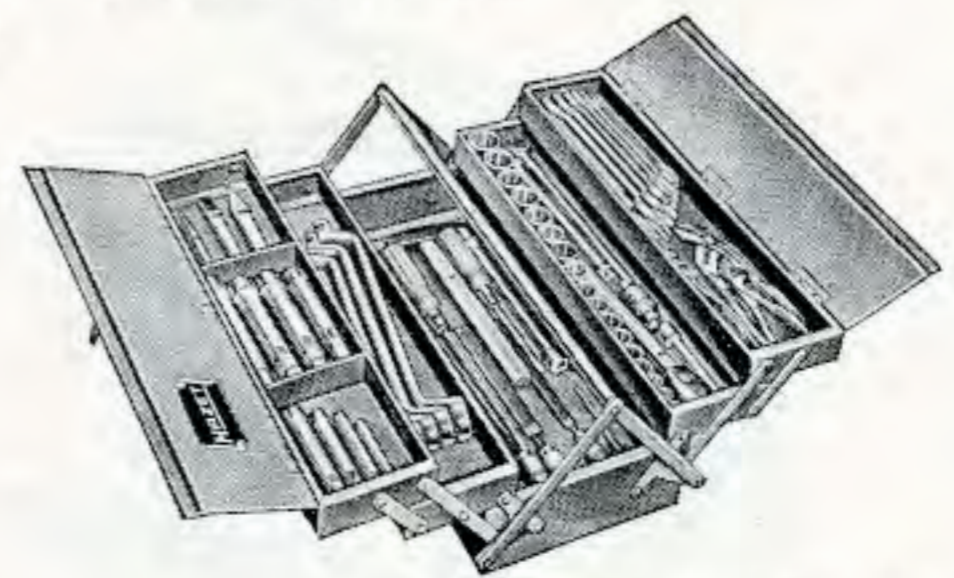

Kastengröße: 530 x 200 x 200 mm

INHALTSÜBERSICHT

Nr.	Bezeichnung	Metr. 56 teilig HAZET 804-4	Amer. 52 teilig HAZET 804-4A	Engl. 41 teilig HAZET 804-4W		
450	Gabelschlüssel	6 x 7	1/4 x 5/16	1/16 x 3/32		
		8 x 9	5/16 x 3/8	3/32 x 1/8		
		10 x 11	5/16 x 7/16	1/8 x 3/16		
		12 x 13	3/8 x 13/32	3/16 x 1/4		
		14 x 15	1/2 x 9/16	1/4 x 5/16		
		16 x 17	9/16 x 5/8	5/16 x 3/8		
		18 x 19	19/32 x 11/16	3/8 x 7/16		
		20 x 22	5/8 x 3/4	7/16 x 1/2		
		21 x 23	25/32 x 13/16	1/2 x 9/16		
		24 x 26	7/8 x 15/16	9/16 x 5/8		
		25 x 28	15/16 x 1	5/8 x 3/4		
		27 x 32	1 x 1 1/8			
		36 x 41				
		630	Ringschlüssel, gekröpft	6 x 7	1/4 x 5/16	1/8 x 3/16
				8 x 9	3/8 x 7/16	3/16 x 1/4
				10 x 11	1/2 x 9/16	1/4 x 5/16
				12 x 13	19/32 x 11/16	5/16 x 3/8
14 x 15	5/8 x 3/4			3/8 x 7/16		
16 x 17	25/32 x 13/16			7/16 x 1/2		
18 x 19	7/8 x 15/16			1/2 x 9/16		
20 x 22	15/16 x 1			9/16 x 5/8		
21 x 23	1 x 1 1/8					
24 x 26	1 1/16 x 1 1/4					
25 x 28						
27 x 32						
36 x 41						
900 Z	Zwölfkant-Einsätze 1/2" □ Antrieb	12 13 14	3/8 7/16 1/2	3/16 1/4 5/16		
		15 16 17	9/16 19/32 5/8	3/8 7/16 1/2		
		18 19 20	11/16 3/4 25/32	9/16 5/8 11/16		
		21 22 23	13/16 7/8 15/16	3/4		
		24 26 27	31/32 1 11/16			
		28 30 32	1 1/8 1 3/16 1 1/4			

ALLE SORTIMENTE (804-4 - 804-4A - 804-4W) enthalten außerdem:

760-3	Universalzange 9 1/2"	915	T-Griff 12"
760-4	dito 15"	916	Umschaltknarre 12"
811-6	Schraubendreher 125 x 7	917	Verlängerung 5"
811-13	dito 200 x 10	918	Verlängerung 10"
813-3	dito 100 x 3,5	920	Universalgelenk
	Betätigungswerkzeuge 1/2" □ Antrieb	980-13	Schraubendreher-Einsatz 13 x 2
911	Schwunggriff 16 1/2"		





Motorrad-Werkzeugsatz CHROM-VANADIUM

805

in Plastic-Tasche, 10teilig

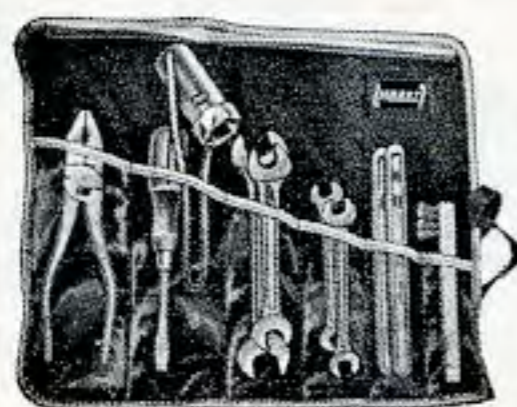

Bestell-Nr.	Inhalt	Verchromt
450	Gabelschlüssel 8 x 10 9 x 11 12 x 14 17 x 19	
650-6	Reifenheber 6", 2 Stück	
766	Zündkerzenschlüssel 21	
812	Schraubendreher 50 x 6	
1850-2	Kombizange 6 1/2"	
2131	Zündkerzenbürste	
805		34.—



Herrenfahrer-Werkzeugsatz CHROM-VANADIUM

806

in Plastic-Tasche, 9teilig



Metr. Maße

450	Gabelschlüssel 8 x 9 10 x 11 12 x 13 14 x 17 19 x 22	
760-3	Universalzange 9 1/2"	
761	Zündkerzenschlüssel 21 x 26	
811-9	Schraubendreher 150 x 8	
2131	Zündkerzenbürste	
806		38.70

Amerik. Maße

450 A	wie vor, jedoch Gabelschlüssel 5/16 x 13/32 3/8 x 7/16 1/2 x 9/16 19/32 x 11/16 25/32 x 7/8	
761 A	Zündkerzenschlüssel 13/16 x 1	
806 A		38.70



Herrenfahrer-Werkzeugsatz CHROM-VANADIUM

808

in Vollrindleder-Tasche mit Reißverschluß,
15teilig



Metr. Maße

450	Gabelschlüssel 6 x 7 8 x 9 10 x 11 12 x 13 14 x 15 16 x 17 18 x 19 20 x 22	
730-3	Flachmeißel 150 x 18	
746-2	Körner 120 x 12	
760-3	Universalzange 9 1/2"	
764	Zündkerzenschlüssel 21	
811-9	Schraubendreher 150 x 8	
1850-3	Kombizange 7"	
2140-3	Hammer 300 g	
808		134.20



Herrenfahrer-Werkzeugsatz CHROM-VANADIUM

808

Amerik. Maße

Bestell-Nr.	Inhalt	Verchromt
450 A	Gabelschlüssel 1/4 x 5/16 5/16 x 13/32 3/8 x 7/16 1/2 x 9/16 9/16 x 5/8 19/32 x 11/16 5/8 x 3/4 25/32 x 13/16	
730-3	Flachmeißel 150 x 18	
746-2	Körner 120 x 12	
760-3	Universalzange 9 1/2"	
764	Zündkerzenschlüssel 13/16"	
811-9	Schraubendreher 150 x 8	
1850-3	Kombizange 7"	
2141-1	Hammer 3/4 lbs.	
808 A		135.30



Großer Werkzeugsatz CHROM-VANADIUM

809

in Plastic-Tasche, 20teilig



Metr. Maße

450	Gabelschlüssel 6 x 7 8 x 9 10 x 11 12 x 13 14 x 15 16 x 17 18 x 19 20 x 22	
650-12	Reifenheber 12", 2 Stück	
730-3	Flachmeißel 150 x 18	
745-12	Durchschläger 120 x 4	
746-2	Körner 120 x 12	
760-3	Universalzange 9 1/2"	
764	Zündkerzenschlüssel 21	
768-19	Radmutterenschlüssel 19 Stecker dazu	
811-6	Schraubendreher 125 x 7	
1850-3	Kombizange 7"	
2140-3	Hammer 300 g	
809		96.80

Amerik. Maße

450 A	Gabelschlüssel 1/4 x 5/16 5/16 x 13/32 3/8 x 7/16 1/2 x 9/16 9/16 x 5/8 19/32 x 11/16 5/8 x 3/4 25/32 x 13/16	
650-12	Reifenheber 12", 2 Stück	
730-3	Flachmeißel 150 x 18	
745-12	Durchschläger 120 x 4	
746-2	Körner 120 x 12	
760-3	Universalzange 9 1/2"	
764	Zündkerzenschlüssel 13/16"	
768-19	Radmutterenschlüssel 19 Stecker dazu	
811-6	Schraubendreher 125 x 7	
1850-3	Kombizange 7"	
2141-1	Hammer 3/4 lbs.	
809 A		97.90



Werkstatt-Schraubendreher

CHROM-VANADIUM

durchgehende Klinge

Holzheft

811



Bestell-Nr.	Klingen-Länge/Breite		Klingen-Länge/Breite		Total-Länge		Pack-Norm	Preis
	mm	Zoll	mm	Zoll	mm	Zoll		
811-1	75 x 5	3 x 3/16	180	7	5	2.90		
2	100 x 5	4 x 3/16	210	8 1/4	5	3.10		
3	100 x 6	4 x 1/4	225	9	5	3.50		
4	150 x 6	6 x 1/4	245	9 3/4	5	3.70		
5	100 x 7	4 x 9/32	275	11	5	3.70		
6	125 x 7	5 x 9/32	270	10 3/4	5	3.90		
7	150 x 7	6 x 9/32	290	11 1/2	5	4.30		
8	100 x 8	4 x 5/16	250	9 3/4	5	4.30		
9	150 x 8	6 x 5/16	295	11 1/2	5	4.60		
10	200 x 8	8 x 5/16	340	13 1/2	5	4.80		
11	200 x 9	8 x 11/32	340	13 1/2	5	4.90		
12	150 x 10	6 x 3/8	300	11 3/4	5	5.20		
13	200 x 10	8 x 3/8	370	14 1/2	5	5.50		
14	250 x 10	10 x 3/8	410	16	5	5.90		
15	200 x 12	8 x 15/32	365	14 1/2	5	6.50		
16	250 x 12	10 x 15/32	415	16 1/4	5	6.90		



Motorrad-Schraubendreher

CHROM-VANADIUM

Holzheft

812



812	50 x 6	2 x 1/4	145	5 3/4	5	1.60
-----	--------	---------	-----	-------	---	------



Elektriker-Schraubendreher

CHROM-VANADIUM

Holzheft

813



813-1	60 x 2,5	2 1/4 x 3/32	155	6	5	1.50
2	80 x 3	3 1/4 x 1/8	175	7	5	1.60
3	100 x 3,5	4 x 1/8	195	7 3/4	5	1.80
4	120 x 4	4 3/4 x 5/32	220	8 3/4	5	2.—
5	140 x 5	5 1/2 x 3/16	240	9 1/2	5	2.20
6	160 x 5	6 1/4 x 3/16	245	9 3/4	5	2.50



Kreuzschlitz-Schraubendreher

CHROM-VANADIUM

Spitzen PHILLIPS-RECESS nach DIN 5261

Holzheft

814



Bestell-Nr.	Klingen-Länge / ø		für Schrauben Nr.	Total-Länge		Pack-Norm	Preis
	mm	Zoll		mm	Zoll		
814-0	60 x 3	2 1/4 x 1/8	0-1	145	5 3/4	5	2.50
1	80 x 4	3 1/4 x 5/32	2-4	175	7	5	2.60
2	100 x 6	4 x 1/4	5-10	210	8 1/4	5	3.50



814

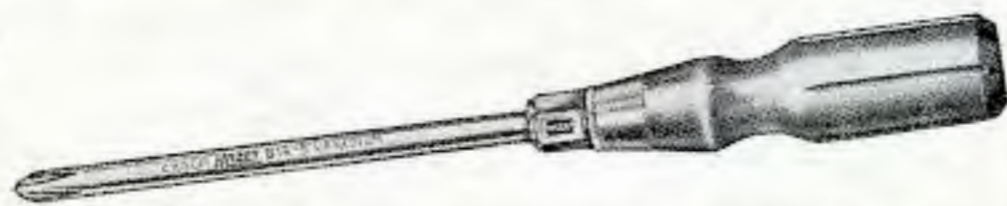

Klinge mit Sechskant

814-3	150 x 8	6 x 5/16	12-16	270	10 3/4	5	6.50
4	200 x 11	8 x 7/16	18 u. größer	330	13	5	8.70



814



kurze Form

814-01	30 x 4	1 1/4 x 5/32	2-4	90	3 1/2	5	2.40
02	40 x 6	1 1/2 x 1/4	5-10	100	4	5	2.80



Schraubendreher

CHROM-VANADIUM

durchgehende Vierkantklinge mit Sechskant

Holzheft

815



gesenkgeschmiedet

Bestell-Nr.	Klingen-Länge/Breite		Klingen-Länge/Breite		Total-Länge		Pack-Norm	Preis
	mm	Zoll	mm	Zoll	mm	Zoll		
815-1	100 x 5,5	4 x 7/32	200	8	5	4.50		
2	125 x 7	5 x 9/32	240	9 1/2	5	5.40		
3	150 x 9	6 x 11/32	270	10 3/4	5	7.10		
4	175 x 10	7 x 3/8	305	12	5	8.40		
5	200 x 11	8 x 7/16	335	13 1/4	5	9.70		
6	250 x 13	10 x 1/2	395	15 1/2	5	11.20		



Winkelschraubendreher

CHROM-VANADIUM

gesenkgeschmiedet, Klingenstellung 90° und 45°

818



Bestell-Nr.	Klingen-Länge/Breite		Klingen-Länge/Breite		Pack-Norm	Preis	
	90°	45°	mm	Zoll		90°	45°
818-1	818-11	100 x 4	4 x 5/32	5	2.90	3.10	
2	22	125 x 6	5 x 1/4	5	3.40	3.60	
3	33	150 x 8	6 x 5/16	5	4.20	4.30	
4	44	175 x 10	7 x 3/8	5	4.90	5.20	
5	55	200 x 13	8 x 1/2	5	5.80	6.20	



Kreuzschlitz-Winkelschraubendreher

CHROM-VANADIUM

Spitzen PHILLIPS-RECESS nach DIN 5261

819



Bestell-Nr.	Klingen-Länge / ø		für Schrauben Nr.	Pack-Norm	Preis
	mm	Zoll			
819-1	100 x 6	4 x 1/4	2-10	5	4.20
2	150 x 10	6 x 3/8	12-18 u. größer	5	6.20

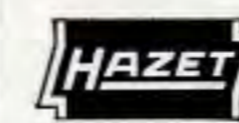

Schaber

CHROM-VANADIUM

Holzheft

820-824



Dreikant-Löffelschaber

Bestell-Nr.	Klingen-Länge		Löffel-Länge		Total-Länge		Pack-Norm	Preis
	mm	Zoll	mm	Zoll	mm	Zoll		
820-1	125	5	55	2 1/4	230	9	5	4.70
2	150	6	70	2 3/4	265	10 1/2	5	5.30
3	200	8	85	3 1/4	315	12 1/2	5	6.70
4	250	10	100	4	370	14 1/2	5	8.—

Dreikant-Hohlschaber

821-1	150	6	—	—	265	10 1/2	5	5.70
2	200	8	—	—	315	12 1/2	5	6.70
3	250	10	—	—	370	14 1/2	5	7.30
4	300	12	—	—	430	17	5	8.—

Löffel- oder Lagerschaber

824-1	125	5	45	1 3/4	230	9	5	4.90
2	150	6	65	2 1/2	265	10 1/2	5	5.70
3	200	8	85	3 1/4	315	12 1/2	5	6.90
4	250	10	100	4	370	14 1/2	5	8.40



Werkstatt-Schraubendreher CHROM-VANADIUM

830

mit runder Klinge
verstärktes Transparentheft nach DIN 5268 Form K



Bestell-Nr.	Klingen-Länge/Breite mm	Klingen-Länge/Breite Zoll	Total-Länge		Pack-Norm	Preis
			mm	Zoll		
830-1	75 x 5	3 x 3/16	170	6 3/4	5	3.30
2	100 x 5	4 x 3/16	195	7 3/4	5	3.40
3	100 x 6	4 x 1/4	205	8	5	4.40
4	150 x 6	6 x 1/4	255	10	5	4.60
5	100 x 7	4 x 9/32	210	8 1/4	5	4.60
6	125 x 7	5 x 9/32	235	9 1/4	5	4.70
7	150 x 7	6 x 9/32	260	10 1/4	5	4.90
8	100 x 8	4 x 5/16	210	8 1/4	5	4.90
9	150 x 8	6 x 5/16	260	10 1/4	5	5.40
10	200 x 8	8 x 5/16	315	12 1/2	5	6.30
11	200 x 9	8 x 11/32	315	12 1/2	5	6.50
12	150 x 10	6 x 3/8	270	10 1/2	5	6.60
13	200 x 10	8 x 3/8	320	12 1/2	5	6.90
14	250 x 10	10 x 3/8	370	14 1/2	5	7.80
15	200 x 12	8 x 15/32	320	12 1/2	5	8.—
16	250 x 12	10 x 15/32	370	14 1/2	5	8.40



Werkstatt-Schraubendreher CHROM-VANADIUM

831

mit Vierkantklinge
Transparentheft



Bestell-Nr.	Klingen-Länge/Breite mm	Klingen-Länge/Breite Zoll	Total-Länge		Pack-Norm	Preis
			mm	Zoll		
831-1	75 x 6	3 x 1/4	160	6 1/4	5	3.60
2	100 x 6	4 x 1/4	190	7 1/2	5	3.90
3	150 x 6	6 x 1/4	245	9 3/4	5	4.90
4	100 x 8	4 x 5/16	195	7 3/4	5	5.20
5	150 x 8	6 x 5/16	255	10	5	6.30
6	200 x 8	8 x 5/16	300	11 3/4	5	7.—
7	150 x 10	6 x 3/8	265	10 1/2	5	7.90
8	200 x 10	8 x 3/8	310	12 1/4	5	8.40
9	250 x 10	10 x 3/8	365	14 1/2	5	9.10



Elektriker-Schraubendreher CHROM-VANADIUM

832

verstärktes Transparentheft nach DIN 5268 Form K



Bestell-Nr.	Klingen-Länge/Breite mm	Klingen-Länge/Breite Zoll	Total-Länge		Pack-Norm	Preis
			mm	Zoll		
832-1	60 x 2,5	2 1/4 x 3/32	140	5 1/2	5	2.20
2	80 x 3	3 1/4 x 1/8	160	6 1/4	5	2.30
3	80 x 3,5	3 1/4 x 1/8	160	6 1/4	5	2.50
4	100 x 4	4 x 5/32	190	7 1/2	5	2.90
5	120 x 4	4 3/4 x 5/32	210	8 1/4	5	3.—
6	140 x 5	5 1/2 x 3/16	235	9 1/4	5	3.60
7	160 x 5	6 1/4 x 3/16	255	10	5	3.80
8	200 x 5	8 x 3/16	295	11 1/2	5	4.—

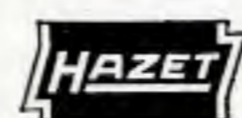

Elektriker-Schraubendreher CHROM-VANADIUM

833

bis an die Schneide isoliert
verstärktes Transparentheft nach DIN 5268 Form K



Bestell-Nr.	Klingen-Länge/Breite mm	Klingen-Länge/Breite Zoll	Total-Länge		Pack-Norm	Preis
			mm	Zoll		
833-1	60 x 2,5	2 1/4 x 3/32	140	5 1/2	5	2.60
2	80 x 3	3 1/4 x 1/8	160	6 1/4	5	2.90
3	80 x 3,5	3 1/4 x 1/8	160	6 1/4	5	3.10
4	100 x 4	4 x 5/32	190	7 1/2	5	3.40
5	120 x 4	4 3/4 x 5/32	210	8 1/4	5	3.60
6	140 x 5	5 1/2 x 3/16	235	9 1/4	5	4.20
7	160 x 5	6 1/4 x 3/16	255	10	5	4.60



Schraubendreher CHROM-VANADIUM

834

für Vergaser, kurze Form
Transparentheft



Bestell-Nr.	Klingen-Länge/Breite mm	Klingen-Länge/Breite Zoll	Total-Länge		Pack-Norm	Preis
			mm	Zoll		
834-1	25 x 5	1 x 3/16	70	2 3/4	5	3.10
2	25 x 6	1 x 1/4	80	3	5	3.30
3	25 x 8	1 x 5/16	80	3	5	4.30
4	25 x 10	1 x 3/8	85	3 1/4	5	4.60



Kreuzschlitz-Schraubendreher CHROM-VANADIUM

835

Spitzen PHILLIPS-RECESS nach DIN 5261
verstärktes Transparentheft nach DIN 5268 Form K



Bestell-Nr.	Klingen-Länge / ø mm	Klingen-Länge / ø Zoll	für Schrauben Nr.	Total-Länge		Pack-Norm	Preis
				mm	Zoll		
835-0	60 x 3	2 1/4 x 1/8	0-1	135	5 1/4	5	3.40
1	80 x 4	3 1/4 x 5/32	2-4	170	6 3/4	5	3.60
2	100 x 6	4 x 1/4	5-10	195	7 3/4	5	5.20



835



Klinge mit Sechskant

835-3	150 x 8	6 x 5/16	12-16	255	10	5	8.10
4	200 x 10	8 x 3/8	18 u. größer	320	12 1/2	5	10.80



835



kurze Form

835-01	30 x 4	1 1/4 x 5/32	2-4	80	3	5	3.60
02	40 x 6	1 1/2 x 1/4	5-10	95	3 3/4	5	4.60



**Werkstatt-Schraubendreher
CHROM-VANADIUM**

836

Vierkantklinge mit Sechskant
verstärktes Transparentheft nach DIN 5268 Form K



gesenkgeschmiedet

Bestell-Nr.	Klingen- Länge/Breite mm	Klingen- Länge/Breite Zoll	Total- Länge		Pack- Norm	Preis
			mm	Zoll		
836 - 1	100 x 6	4 x 1/4	195	7 3/4	5	4.90
2	125 x 7	5 x 9/32	230	9	5	6.30
3	150 x 9	6 x 11/32	260	10 1/4	5	8.—
4	175 x 10	7 x 3/8	290	11 1/2	5	9.90
5	200 x 11	8 x 7/16	320	12 1/2	5	11.20



**Zündkerzenprüfer
CHROM-VANADIUM**

837

mit Neonröhre
Transparentheft

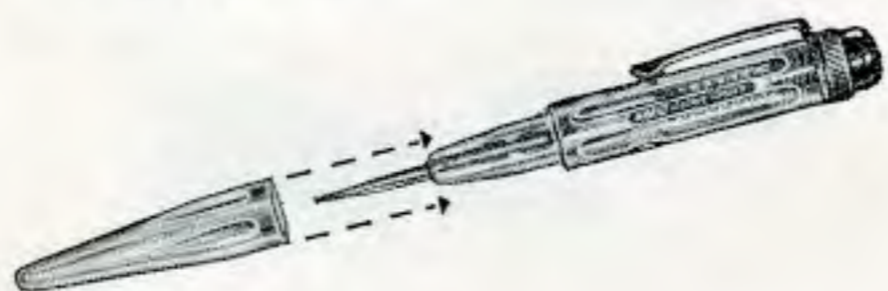

spitz, mit Clip und Schutzkappe

Bestell-Nr.	Spitzenlänge		Total-Länge		Pack- Norm	Preis
	mm	Zoll	mm	Zoll		
837 - 1	50	2	110	4 1/2	5	2.90

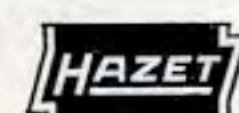

**Zündkerzenprüfer
CHROM-VANADIUM**

837

mit Neonröhre
Transparentheft



Bestell-Nr.	Klingen- Länge/Breite mm	Klingen- Länge/Breite Zoll	Total- Länge		Pack- Norm	Preis
			mm	Zoll		
837 - 1a	100 x 4	4 x 5/32	185	7 1/4	5	4.30
2	100 x 5	4 x 3/16	185	7 1/4	5	4.80

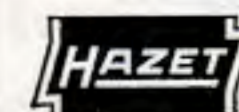

**Ventileinstell-Schraubendreher
CHROM-VANADIUM**

838

für hängende Ventile
Transparentheft



mit eingebauter Feder zum Ausgleich
des Kippspiels

Bestell-Nr.	Total-Länge		Pack- Norm	Preis
	mm	Zoll		
838	180	7 1/4	5	7.20



**Spezienschlüssel
CHROM-VANADIUM**

839

für Schalter des Scheibenwischer-Motors
an Opel-Fahrzeugen
Transparentheft

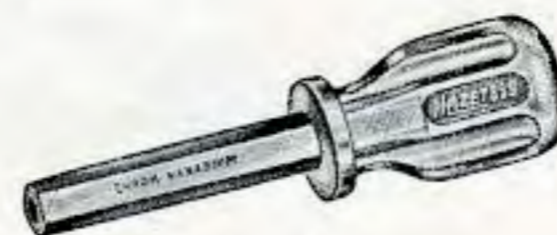

Bestell-Nr.	Sechskant		Klingen-Länge		Total-Länge		Pack- Norm	Preis
	mm	Zoll	mm	Zoll	mm	Zoll		
839 - 09	9	11/32	60	2 1/2	115	4 3/4	5	6.50
10	10	3/8	60	2 1/2	115	4 3/4	5	6.90
14	14	9/16	60	2 1/2	115	4 3/4	5	9.40

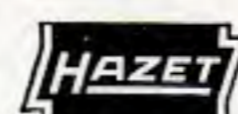

**Schraubenausdreher
CHROM-VANADIUM**

840

für abgebrochene Schrauben und Bolzen



Bestell-Nr.	Ø mm	für Schrauben M	Ø des Spiral- Bohrers	Gewinde- Länge mm	Total- Länge mm	Pack- Norm	Preis
840 - 1	1,4 - 3,6	3 - 6	1,8	13,2	50	10	1.10
2	2,1 - 4,9	6 - 8	2,6	16,8	57	10	1.30
3	3,1 - 6,5	8 - 11	3,7	20,4	64	10	1.50
4	4,8 - 8,8	11 - 14	5,5	24	71	10	1.90
5	6,2 - 11	14 - 18	7	28,8	78	10	2.30
6	9,4 - 15	18 - 24	10,3	33,6	85	10	3.60
7	12,7 - 19	24 - 33	13,7	37,8	92	10	5.30
8	17,5 - 24	33 - 45	18,6	39	100	10	7.50
9	24 - 31	45 - 52	25	42	112	5	12.30
10	31 - 39	52 - 64	33	48	122	5	27.70
11	39 - 48	64 - 76	41	54	134	5	38.90
12	48 - 59	76 - 89	50	66	150	5	59.—

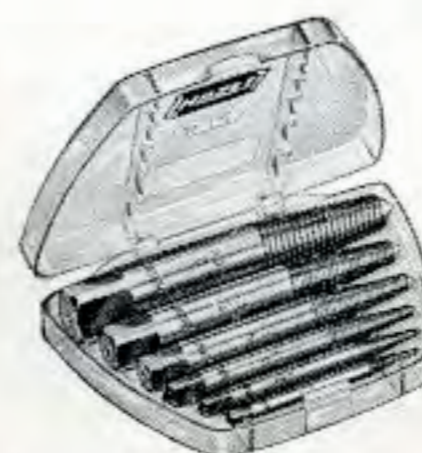

Vorböhrer der Löcher
durch passende Spiralbohrer
(siehe Tabelle oben)

Durch Linksdrehen des
Schraubenausdreher wird
der Schraubenrest gelöst

Sätze in
Plastic-Behältern

Bestell-Nr.	Inhalt	Preis
840 - 15	1 - 5	9.20
16	1 - 6	13.40
18	1 - 8	26.40

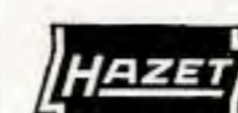

**Stehbolzenauszieher
SPEZIALSTAHL**

845

1/2"

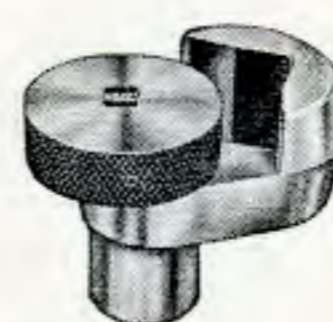

Zum Ein- und Ausdrehen
von Stehbolzen mit
Rechts- und Linksgewinde

Bestell-Nr.	Spannweite		Pack- Norm	Blank poliert
	mm	Zoll		
845 - 13	13	1/2	1	21.80
19	19	3/4	1	33.90
25	25	1	1	49.30



Steckschlüsselsätze

1/4"

3/8"

1/2"

3/4"

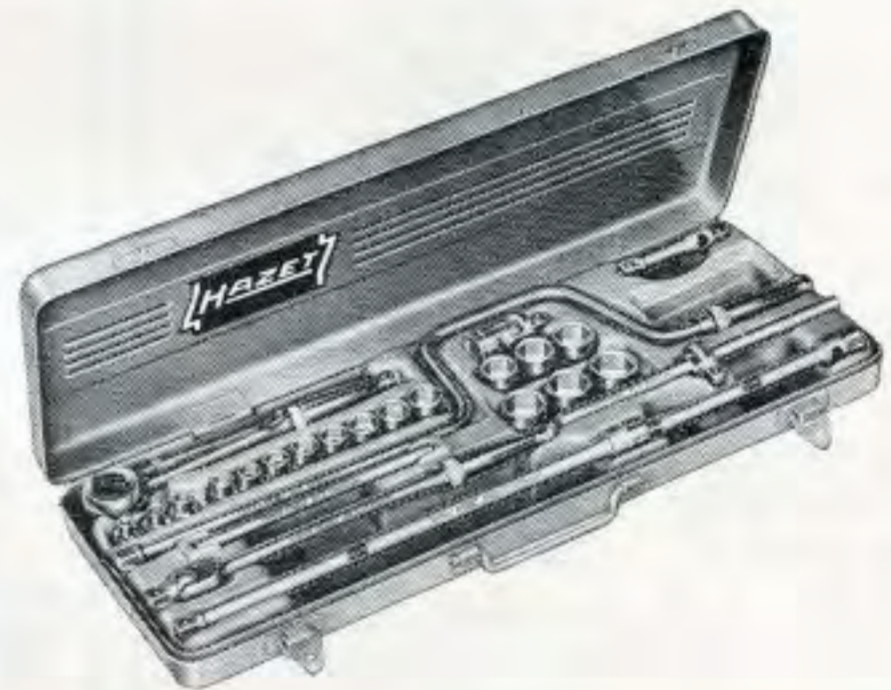



**Steckschlüsselsätze
CHROM-VANADIUM**
mit Sechskant-Einsätzen

850-852
1/4"



Metr. Maße

Bestell-Nr.	Inhalt		Verchromt Köpfe geschliffen
	Einsätze 6-kant	Betätigungs- Werkzeuge	
850	4 4,5 5	865	52.60
	5,5 6 7	866	
	8 9 10	867	
	11	868	
		869	
851	wie 850	wie 850 zusätzlich 760-1 833-1	62.30
852	wie 850	863 864 865 866 867 868 869	91.—

Amerik. Maße

850 A	3/16 7/32	865	47.50
	1/4 9/32	866	
	5/16 11/32	867	
	3/8 7/16	868	
		869	
851 A	wie 850 A	wie 850 A zusätzlich 760-1 833-1	57.20
852 A	wie 850 A	863 864 865 866 867 868 869	86.20

Engl. Maße

850 W	8 BA 7 BA	865	49.90
	6 BA 5 BA	866	
	4 BA 3 BA	867	
	2 BA 1 BA	868	
	0 BA	869	
851 W	wie 850 W	wie 850 W zusätzlich 760-1 833-1	60.—
852 W	wie 850 W	863 864 865 866 867 868 869	88.60



**Steckschlüsselsätze
CHROM-VANADIUM**
mit Sechskant-Einsätzen

853
1/4"

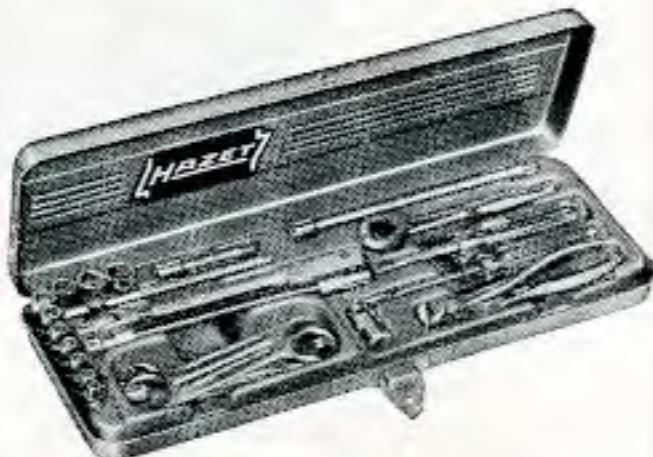

Metr. Maße

853	4 4,5 5	863 864	149.—
	5,5 6 7	865 866	
	8 9 10	867 868	
	11	869 870	
		760-1 833-1	
	Kleingabelschlüssel 330		
	3,5 x 4	4 x 3,5	
	4,5 x 5	5 x 4,5	
	5,5 x 6	6 x 5,5	
	7 x 8	8 x 7	
	9 x 10	10 x 9	
	11 x 12	12 x 11	



**Steckschlüsselsätze
CHROM-VANADIUM**
mit Sechskant-Einsätzen

853
1/4"

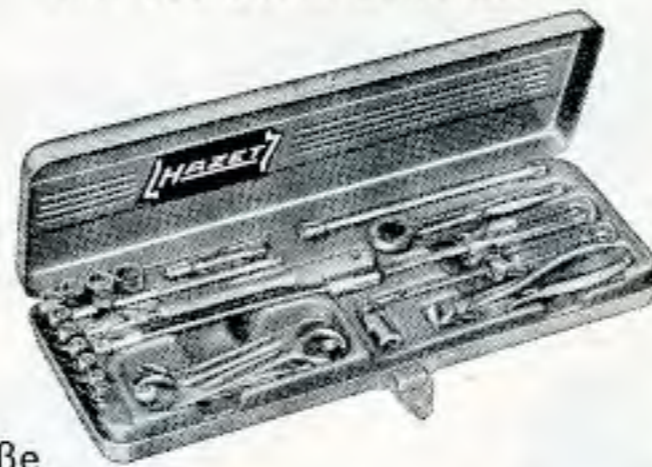

Amerik. Maße

Bestell-Nr.	Inhalt		Verchromt Köpfe geschliffen
	Einsätze 6-kant	Betätigungs- Werkzeuge	
853 A	3/16 7/32	863 864	134.90
	1/4 9/32	865 866	
	5/16 11/32	867 868	
	3/8 7/16	869 870	
		760-1 833-1	
	Kleingabelschl. 330 A		
	13/64 x 15/64	15/64 x 13/64	
	7/32 x 1/4	1/4 x 7/32	
	9/32 x 5/16	5/16 x 9/32	
	11/32 x 3/8	3/8 x 11/32	
	7/16 x 1/2		

Engl. Maße

853 W	8 BA 7 BA	863 864	139.50
	6 BA 5 BA	865 866	
	4 BA 3 BA	867 868	
	2 BA 1 BA	869 870	
	0 BA	760-1 833-1	
	Kleingabelschl. 330 W		
	9 x 8 BA	8 x 9 BA	
	7 x 6 BA	6 x 7 BA	
	5 x 4 BA	4 x 5 BA	
	3 x 2 BA	2 x 3 BA	
	1 x 0 BA	0 x 1 BA	



**Sechskant-Einsätze
CHROM-VANADIUM**

850
1/4"



Metr. Maße

Bestell-Nr. u. Größe	Einsatzhöhe mm	Pack- Norm	Verchromt Köpfe geschliffen
850			2.50
4	25	10	
4,5	25	10	
5	25	10	
5,5	25	10	
6	25	10	
7	25	10	
8	25	10	
9	25	10	
10	25	10	
11	25	10	

Amerik. Maße

850 A	3/16	25	10	2.50
	7/32	25	10	
	1/4	25	10	
	9/32	25	10	
	5/16	25	10	
	11/32	25	10	
	3/8	25	10	
	7/16	25	10	

Engl. Maße

850 W	8 BA	25	10	2.50
	7 BA	25	10	
	6 BA	25	10	
	5 BA	25	10	
	4 BA	25	10	
	3 BA	25	10	
	2 BA	25	10	
	1 BA	25	10	
	0 BA	25	10	



**Achtkant-Einsätze
CHROM-VANADIUM**

850
1/4"



Amerik. Maße

Bestell-Nr. u. Größe	Einsatzhöhe mm	Pack- Norm	Verchromt Köpfe geschliffen
850 AK			2.50
1/4	25	10	
5/16	25	10	
3/8	25	10	



**Betätigungswerkzeug
CHROM-VANADIUM**

858-870
1/4"

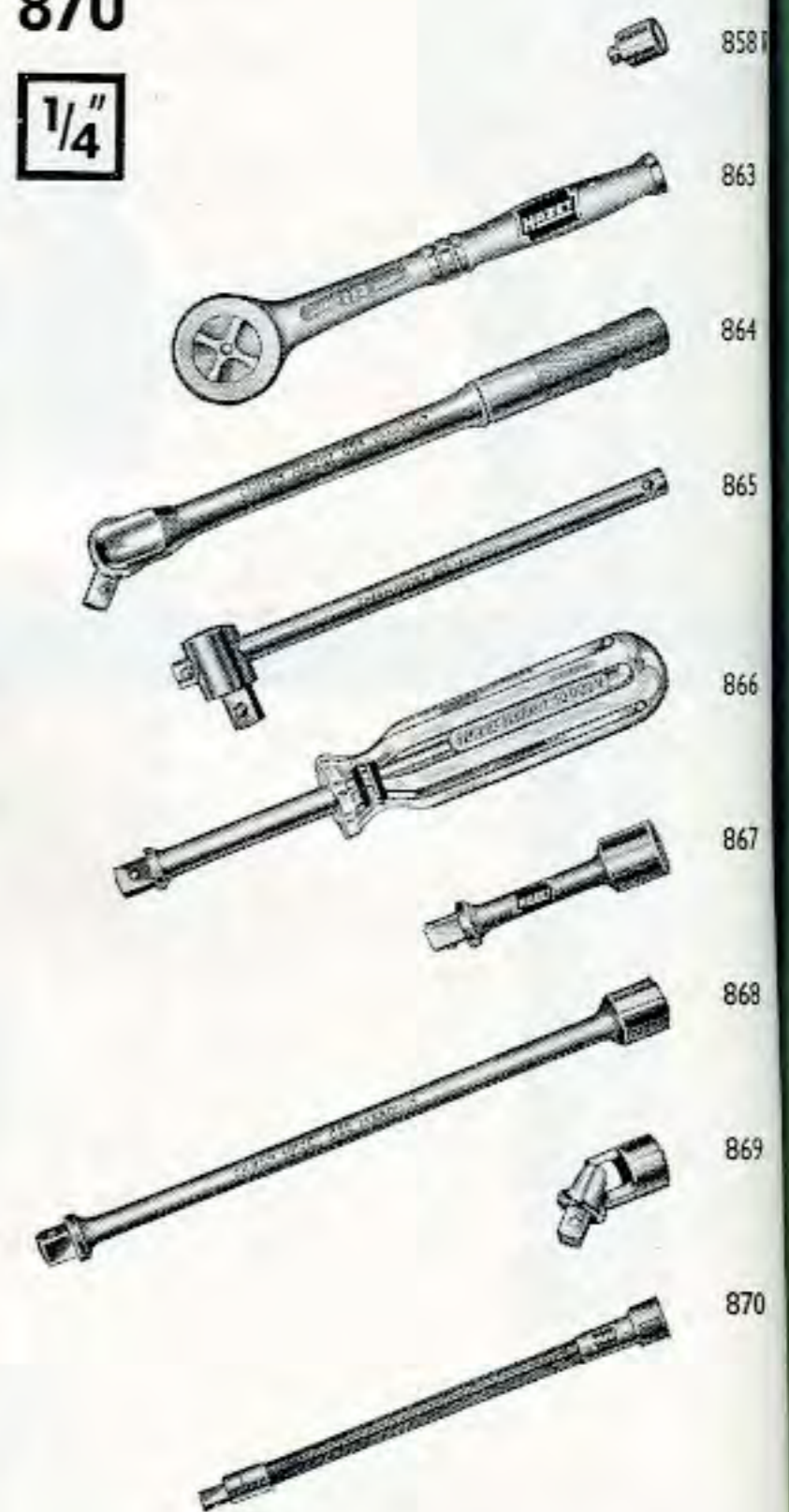

Bestell-Nr.	Bezeichnung	Pack- Norm	Verchr. Köpfe geschl.
858 RI	Reduziereinsatz 1/4" <input type="checkbox"/> massiv 3/8" <input type="checkbox"/> hohl	10	3.60
858 RII	Reduziereinsatz 3/8" <input type="checkbox"/> massiv 1/4" <input type="checkbox"/> hohl	10	3.90
863	Umschaltknarre 4 1/2"	5	19.60
863 E	Komplettes Einsatzteil mit Drehknopf und Federring	5	12.30
864	Gelenkgriff 6"	5	10.10
865	Schiebegriff 5"	10	3.90
866	Vierkantknebel 5"	5	6.40
867	Verlängerung 2"	10	3.60
868	Verlängerung 6"	10	4.60
869	Kardangelenk	10	7.90
870	biegsame Verlängerung 6"	10	6.40

HAZET Steckschlüsselsätze
CHROM-VANADIUM

mit Sechskant-Einsätzen

880-
881

3/8"

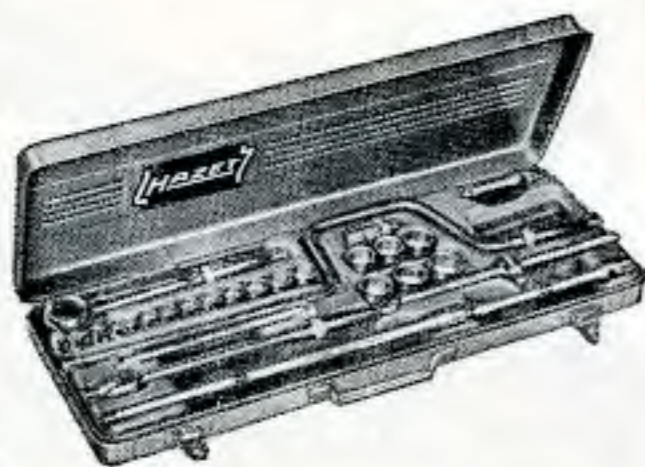

Metr. Maße

Bestell-Nr.	Inhalt		Verchromt Köpfe geschliffen
	Einsätze 6-kant	Betätigungs- Werkzeuge	
880	9 10 11	8811 8813	150.70
	12 13 14	8814 8815	
	15 16 17	8816 8820	
	18 19 20	8821-3, 6, 12	
	21 22		
881	wie 880 zusätzlich 6 7 8	wie 880	158.60

Amerik. Maße

880 A	1/4	5/16	8811 8813	132.90
	3/8	7/16	8814 8815	
	1/2	9/16	8816 8820	
	5/8	11/16	8821-3, 6, 12	
	3/4			

HAZET Steckschlüsselsätze
CHROM-VANADIUM

mit Zwölfkant-Einsätzen

880 Z-
882 Z

3/8"

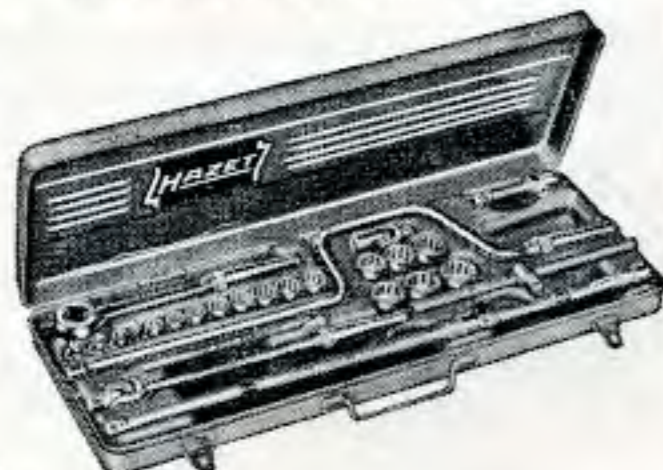

Metr. Maße

Bestell-Nr.	Inhalt		Verchromt Köpfe geschliffen
	Einsätze 12-kant	Betätigungs- Werkzeuge	
880 Z	9 10 11	8811 8813	150.70
	12 13 14	8814 8815	
	15 16 17	8816 8820	
	18 19 20	8821-3, 6, 12	
	21 22		
881 Z	wie 880 Z zusätzlich 6-kant- Einsätze 6 7 8	wie 880 Z	158.60

Amerik. Maße

881 AZ	3/8	7/16	8811 8813	141.70
	1/2	9/16	8814 8815	
	19/32	5/8	8816 8820	
	11/16	3/4	8821-3, 6, 12	
	25/32	13/16		
	7/8			

882 AZ	wie 881AZ zusätzlich 6-kant- Einsätze 1/4 5/16	wie 881 AZ	146.90
--------	--	------------	--------

Amerik. u. engl. Maße

880 AWZ	3/8	7/16	8811 8813	163.70
	1/2	9/16	8814 8815	
	19/32	5/8	8816 8820	
	11/16	3/4	8821-3, 6, 12	
	25/32	13/16		
	7/8 A			
	1/8	3/16		
1/4	5/16			
3/8	7/16			
1/2 W				

HAZET Steckschlüsselsätze
CHROM-VANADIUM

mit Sechskant-Einsätzen

883-
884

3/8"



Metr. Maße

Bestell-Nr.	Inhalt		Verchromt Köpfe geschliffen
	Einsätze 6-kant	Betätigungs- Werkzeuge	
883	6 7 8	8813 8814	87.30
	9 10 11	8821-6	
	12 13 14		
	15 16 17		
	18 19 20		
21 22			
884	wie 883	wie 883 zusätzlich 8816	113.70

Amerik. Maße

884 A	1/4	5/16	8813 8814	88.—
	3/8	7/16	8816	
	1/2	9/16	8821-6	
	5/8	11/16		
	3/4			

HAZET Steckschlüsselsätze
CHROM-VANADIUM

mit Zwölfkant-Einsätzen

883 Z-
884 Z

3/8"



Metr. Maße

Bestell-Nr.	Inhalt		Verchromt Köpfe geschliffen
	Einsätze 12-kant	Betätigungs- Werkzeuge	
883 Z	9 10 11	8813 8814	79.40
	12 13 14	8821-6	
	15 16 17		
	18 19 20		
	21 22		
884 Z	wie 883 Z	wie 883 Z zusätzlich 8816	105.80

Amerik. Maße

884 AZ	3/8	7/16	8813 8814	100.50
	1/2	9/16	8816	
	19/32	5/8	8821-6	
	11/16	3/4		
	25/32	13/16		
	7/8	15/16		

Amerik. u. engl. Maße

884 AWZ	3/8	7/16	8813 8814	104.90
	1/2	9/16	8816	
	5/8	3/4	8821-6	
	7/8 A			
	1/8	3/16		
	1/4	5/16		
	3/8	7/16		
1/2 W				

HAZET Steckschlüsselsätze
CHROM-VANADIUM

mit Sechskant- und
Zwölfkant-Einsätzen

888 Z

3/8"



Metr. Maße

Bestell-Nr.	Inhalt	Verchromt Köpfe geschliffen
888 Z	Sechskant-Einsätze: 6 7 8	360.80
	Zwölfkant-Einsätze: 9 10 11 12 13 14 15 16 17 18 19 20 21 22	
	Zwölfkant-Einsätze, extra tief: 9 10 11 12 13 14 15 16 17 18 19 20 21 22	
	Einsätze für Innen- Sechskantschrauben: 3 4 5 6 7 8 9 10 12	
	Schraubendreher- Einsätze, auswechselbar: 6 8 10	
	Schraubendreher- Einsatz, fest: 17	
	Schraubendreher- Einsätze für Kreuz- schlitzschrauben: Größe 2 3 4	
	Betätigungswerkzeuge: 8811 8812 8813 8814 8815 8816 8820 8821 - 3, 6, 8, 12 8830 858 RI	

Amerik. Maße

888 AZ	wie 888 Z, jedoch	321.20
	Sechskant-Einsätze: 1/4 5/16	
	Zwölfkant-Einsätze: 3/8 7/16 1/2 9/16 19/32 5/8 11/16 3/4 25/32 13/16 7/8 15/16	
	Zwölfkant-Einsätze, extra tief: 3/8 7/16 1/2 9/16 19/32 5/8 11/16 3/4 13/16 7/8	
	Einsätze für Innen- Sechskantschrauben: 1/8 5/32 3/16 7/32 1/4 5/16 3/8	



Sechskant-Einsätze
CHROM-VANADIUM

880

3/8



Metr. Maße

Bestell-Nr. u. Größe	Einsatzhöhe mm	Pack-Norm	Verchromt Köpfe geschl.
880 6	24	10	
7	24	10	
8	24	10	2.60
9	24	10	
10	24	10	
11	24	10	
12	25	10	2.80
13	25	10	
14	25	10	
15	25	10	2.90
16	26	10	
17	26	10	
18	27	10	3.50
19	28	10	
20	28	10	
21	29	10	3.70
22	30	10	

Amerik. Maße

880 A 1/4	24	10	
5/16	24	10	2.60
3/8	24	10	
7/16	24	10	2.80
1/2	25	10	
9/16	25	10	2.90
5/8	25	10	
11/16	27	10	3.50
3/4	28	10	



Zwölfkant-Einsätze
CHROM-VANADIUM

880 Z

3/8



Metr. Maße

880 Z 9	24	10	2.60
10	24	10	
11	24	10	2.80
12	25	10	
13	25	10	
14	25	10	
15	25	10	2.90
16	26	10	
17	26	10	
18	27	10	3.50
19	28	10	
20	28	10	
21	29	10	3.70
22	30	10	

Amerik. Maße

880 AZ 11/32	24	10	
3/8	24	10	2.60
7/16	24	10	
1/2	25	10	2.80
9/16	25	10	
19/32	25	10	2.90
5/8	25	10	
11/16	27	10	3.50
3/4	28	10	
25/32	28	10	
13/16	29	10	3.70
7/8	30	10	
15/16	32	10	

Engl. Maße

880 WZ 1/8	24	10	2.60
3/16	24	10	
1/4	25	10	2.80
5/16	25	10	2.90
3/8	27	10	3.50
7/16	29	10	
1/2	30	10	3.70



Zwölfkant-Einsätze
CHROM-VANADIUM

880 TZ

3/8

extra tief



Metr. Maße

Bestell-Nr. u. Größe	Einsatzhöhe mm	Pack-Norm	Verchromt Köpfe geschliffen
880 TZ 9	54	10	
10	54	10	
11	54	10	3.90
12	54	10	
13	54	10	4.40
14	54	10	4.60
15	60	10	4.80
16	60	10	5.20
17	60	10	
18	66	10	5.50
19	66	10	
20	70	10	5.90
21	70	10	
22	70	10	6.20

Amerik. Maße

880 TAZ 3/8	54	10	3.90
7/16	54	10	
1/2	54	10	4.40
9/16	60	10	4.60
19/32	60	10	4.80
5/8	60	10	5.20
11/16	66	10	5.50
3/4	66	10	5.90
13/16	70	10	
7/8	70	10	6.20



Einsätze für Innen-
sechskantschrauben
CHROM-VANADIUM

880

3/8



Metr. Maße

auswechselbar

Bestell-Nr. u. Größe	Pack-Norm	Kompl.	Bestell-Nr.	lose Klinge
8801 3	5	4.40	8801 -030	-.70
4	5		040	
5	5	4.60	050	-.90
6	5		060	
7	5	4.80	070	1.10
8	5	5.20	080	1.30
9	5	5.50	090	1.70
10	5	5.90	100	2.—
12	5	6.50	120	2.60

Amerik. Maße

8801 A 1/8	5	4.40	8801 A -040	-.70
5/32	5		050	
3/16	5	4.60	060	-.90
7/32	5		070	
1/4	5	4.80	080	1.10
5/16	5	5.20	100	1.30
3/8	5	5.50	120	1.70



Schraubendreher-
Einsätze
CHROM-VANADIUM

880

3/8



auswechselbar

Bestell-Nr. u. Größe	Pack-Norm	Kompl.	Bestell-Nr.	lose Klinge
8803 6	5	6.20	8803 -60	2.40
8	5	6.80	80	2.90
10	5	7.20	100	3.10

fest

Bestell-Nr. u. Größe	Pack-Norm	Komplett
8804 17	5	2.90



Kreuzschlitzschrauber-
dreher-Einsätze
CHROM-VANADIUM

880

3/8



auswechselbar

Bestell-Nr.	Phillips-Größe	Pack-Norm	Kompl.	Bestell-Nr.	lose Klinge
8806-2 2	2	5	6.50	8806-20	2.80
3	3	5	6.80	30	3.10
4	4	5	7.50	40	3.70



Betätigungswerkzeuge
CHROM-VANADIUM

880

3/8

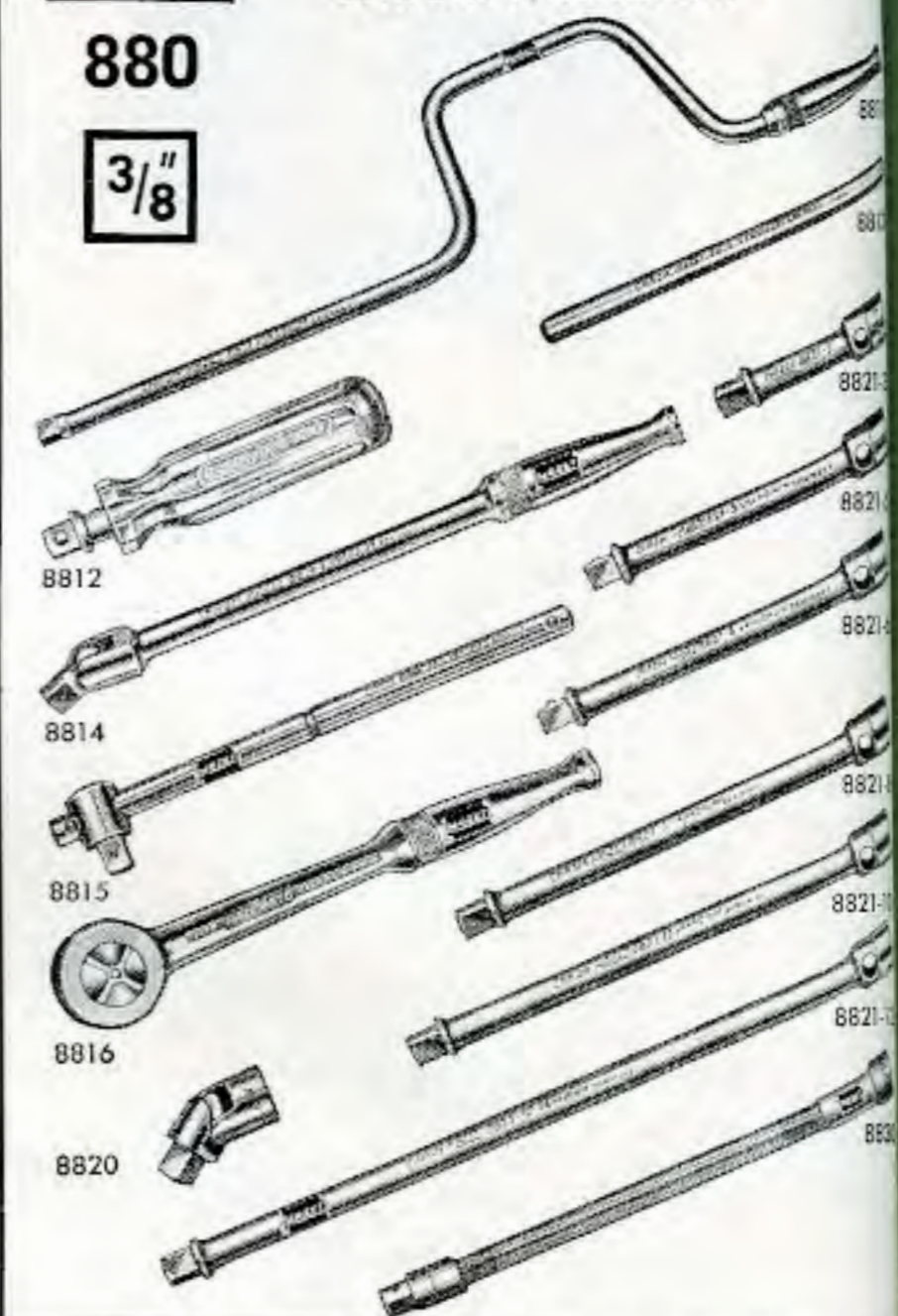

Bestell-Nr.	Bezeichnung	Pack-Norm	Verchr Köpfe geschl.
8811	Schwungwinde 18"	2	9.40
8812	Steckgriff 5"	2	7.90
8813	Stecker 6"	5	2.—
8814	Gelenkgriff 9 1/2"	2	13.40
8815	Schiebegriff 8"	2	6.40
8816	Umschaltknarre 8", 40 Zähne	2	26.40
8816 E	kompl. Einsatzteil mit Drehknopf und Federring	2	15.60
8820	Kardangeln	2	9.—
8821-3	Verlängerung 3"	2	5.—
5	Verlängerung 5"	2	5.40
6	Verlängerung 6"	2	5.50
8	Verlängerung 8"	2	6.40
10	Verlängerung 10"	2	6.80
12	Verlängerung 12"	2	7.—
8830	biegs. Verlänger. 8"	2	7.90



**Steckschlüsselsätze
CHROM-VANADIUM**

**900-
906**

mit Sechskant-Einsätzen

1/2"



Metr. Maße

Bestell-Nr.	Inhalt		Verchromt Köpfe geschliffen
	Einsätze 6-kant	Betätigungs- Werkzeuge	
900	12 13 14 15 16 17 18 19 20 21 22 23 24 26 27 28 30 32	911 915 916 917 918 920 980-13	149.—
901	wie 900	wie 900 zusätzlich 914-15	166.20
904	wie 900 zusätzlich 10 11	wie 900	154.80
905	wie 900 zusätzlich 10 11	wie 900 zusätzlich 914-15	172.—
906	10 11 12 13 14 15 17 19 22 24 27 30 32	911 915 916 918 920	116.80



**Steckschlüsselsätze
CHROM-VANADIUM**

**900 Z-
906 Z**

mit Zwölfkant-Einsätzen

1/2"



Metr. Maße

Bestell-Nr.	Inhalt		Verchromt Köpfe geschliffen
	Einsätze 12-kant	Betätigungs- Werkzeuge	
900 Z	12 13 14 15 16 17 18 19 20 21 22 23 24 26 27 28 30 32	911 915 916 917 918 920 980-13	149.—
901 Z	wie 900 Z	wie 900 Z zusätzlich 914-15	166.20
904 Z	wie 900 Z zusätzlich 10 11	wie 900 Z	154.80
905 Z	wie 900 Z zusätzlich 10 11	wie 900 Z zusätzlich 914-15	172.—
906 Z	10 11 12 13 14 15 17 19 22 24 27 30 32	911 915 916 918 920	116.80



**Steckschlüsselsätze
CHROM-VANADIUM**

**900 Z-
906 Z**

mit Zwölfkant-Einsätzen

1/2"



Amerik. Maße

Bestell-Nr.	Inhalt		Verchromt Köpfe geschliffen
	Einsätze 12-kant	Betätigungs- Werkzeuge	
900 AZ	3/8 7/16 1/2 9/16 19/32 5/8 11/16 3/4 25/32 13/16 7/8 15/16 31/32 1 1 1/16 1 1/8 1 3/16 1 1/4	911 915 916 917 918 920 980-13	148.10
901 AZ	wie 900 AZ	wie 900 AZ zusätzlich 914-15	165.30
906 AZ	3/8 7/16 1/2 9/16 5/8 11/16 3/4 7/8 15/16 1 1 1/16 1 1/4	911 915 916 918 920	112.20

Engl. Maße

900 WZ	3/16 1/4 5/16 3/8 7/16 1/2 9/16 5/8 1 1/16 3/4	911 915 916 917 918 920 980-13	116.40
901 WZ	wie 900 WZ	wie 900 WZ zusätzlich 914-15	133.60

Amerik. u. engl. Maße

900 AWZ	1/2 9/16 5/8 11/16 3/4 25/32 7/8 31/32 1 1 1/16 A 3/16 1/4 5/16 3/8 7/16 1/2 9/16 5/8 W	911 915 916 917 918 920 980-13	144.10
901 AWZ	wie 900 AWZ	wie 900 AWZ zusätzlich 914-15	161.30

Metr., amerik. u. engl. Maße

900 AWM	10 11 12 13 14 15 16 17 18 19 20 21 22 7/16 1/2 9/16 19/32 5/8 11/16 3/4 25/32 7/8 15/16 1 A 3/16 1/4 5/16 3/8 7/16 1/2 9/16 5/8 1 1/16 3/4 W extra tiefe 21 26	911 915 916 917 918	203.50
901 AWM	wie 900 AWM	wie 900 AWM zusätzlich 914-15	220.70



**Steckschlüsselsatz
CHROM-VANADIUM**

**902
AWM**

mit Zwölfkant-Einsätzen

1/2"



Metr., amerik. u. engl. Maße

Bestell-Nr.	Inhalt		Verchromt Köpfe geschliffen
	Einsätze 12-kant	Betätigungs- Werkzeuge	
902 AWM	10 11 12 13 14 15 16 17 18 19 20 21 22 23 24 25 26 27 28 29 30 32 33 3/8 7/16 1/2 9/16 19/32 5/8 11/16 3/4 25/32 13/16 7/8 15/16 31/32 1 1 1/16 1 1/8 1 3/16 1 1/4 A 3/16 1/4 5/16 3/8 7/16 1/2 9/16 5/8 1 1/16 3/4 W extra tief 21	911 913 914-15 915 916 917 918 920 958 R II 1058 R I 980-13 980-19 980-24 962	377.—



**Steckschlüsselsätze
CHROM-VANADIUM**

**930-
944**

mit Sechskant-Einsätzen

1/2"



Metr. Maße

Bestell-Nr.	Inhalt		Verchromt Köpfe geschliffen
	Einsätze 6-kant	Betätigungs- Werkzeuge	
930	12 13 14 15 16 17 18 19 20 21 22 23 24 26 27 28 30 32	916 918	111.50
934	wie 930 zusätzlich 10 11	wie 930	117.30
940	12 13 14 15 16 17 18 19 20 21 22	916 918	74.10
944	wie 940 zusätzlich 10 11	wie 940	79.90



**Steckschlüsselsätze
CHROM-VANADIUM**

**930 Z-
944 Z**

mit Zwölfkant-Einsätzen

1/2"



Metr. Maße

Bestell-Nr.	Inhalt		Verchromt Köpfe geschliffen
	Einsätze 12-kant	Betätigungs- Werkzeuge	
930 Z	12 13 14 15 16 17 18 19 20 21 22 23 24 26 27 28 30 32	916 918	111.50
934 Z	wie 930 Z dazu 10 11	wie 930 Z	117.30
940 Z	12 13 14 15 16 17 18 19 20 21 22	916 918	74.10
944 Z	wie 940 Z dazu 10 11	wie 940 Z	79.90

Amerik. Maße

930 AZ	$\frac{3}{8}$ $\frac{7}{16}$ $\frac{1}{2}$ $\frac{9}{16}$ $\frac{19}{32}$ $\frac{5}{8}$ $\frac{11}{16}$ $\frac{3}{4}$ $\frac{25}{32}$ $\frac{13}{16}$ $\frac{7}{8}$ $\frac{15}{16}$ $\frac{31}{32}$ 1 $\frac{11}{16}$ $\frac{11}{8}$ $\frac{13}{16}$ $\frac{11}{4}$	916 918	110.90
940 AZ	$\frac{3}{8}$ $\frac{7}{16}$ $\frac{1}{2}$ $\frac{9}{16}$ $\frac{19}{32}$ $\frac{5}{8}$ $\frac{11}{16}$ $\frac{3}{4}$ $\frac{25}{32}$ $\frac{13}{16}$ $\frac{7}{8}$	916 918	73.20

Engl. Maße

940 WZ	$\frac{3}{16}$ $\frac{1}{4}$ $\frac{5}{16}$ $\frac{3}{8}$ $\frac{7}{16}$ $\frac{1}{2}$ $\frac{9}{16}$ $\frac{5}{8}$ $\frac{11}{16}$ $\frac{3}{4}$	916 918	79.20
---------------	---	------------	--------------

Amerik. u. engl. Maße

930 AWZ	$\frac{1}{2}$ $\frac{9}{16}$ $\frac{5}{8}$ $\frac{11}{16}$ $\frac{3}{4}$ $\frac{25}{32}$ $\frac{7}{8}$ $\frac{31}{32}$ 1 $\frac{11}{16}$ A $\frac{3}{16}$ $\frac{1}{4}$ $\frac{5}{16}$ $\frac{3}{8}$ $\frac{7}{16}$ $\frac{1}{2}$ $\frac{9}{16}$ $\frac{5}{8}$ W	916 918	107.10
----------------	--	------------	---------------



**Steckschlüsselsätze
CHROM-VANADIUM**

**931-
941**

mit Sechskant-Einsätzen

1/2"



Metr. Maße

Bestell-Nr.	Inhalt		Verchromt Köpfe geschliffen
	Einsätze 6-kant	Betätigungs- Werkzeuge	
931	12 13 14 15 16 17 18 19 20 21 22 23 24 26 27 28 30 32	914-15 918	107.60
941	12 13 14 15 16 17 18 19 20 21 22	914-15 918	70.—



**Steckschlüsselsätze
CHROM-VANADIUM**

**931 Z-
945 Z**

mit Zwölfkant-Einsätzen

1/2"

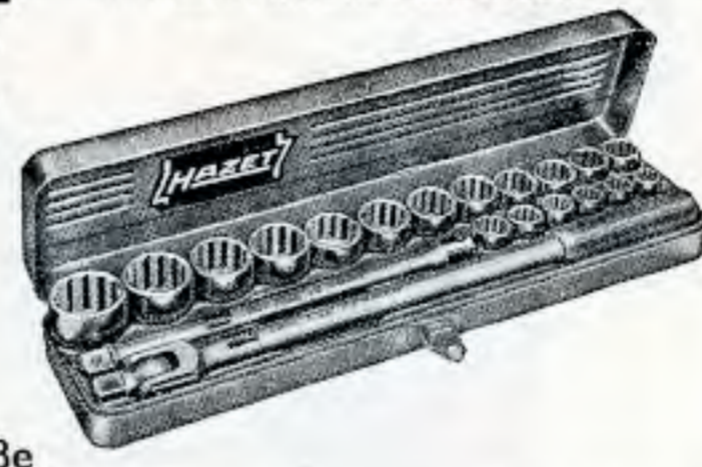

Metr. Maße

Bestell-Nr.	Inhalt		Verchromt Köpfe geschliffen
	Einsätze 12-kant	Betätigungs- Werkzeuge	
931 Z	12 13 14 15 16 17 18 19 20 21 22 23 24 26 27 28 30 32	914-15 918	107.60
935 Z	wie 931 Z dazu 10 11	wie 931 Z	113.40
941 Z	12 13 14 15 16 17 18 19 20 21 22	914-15 918	70.—
945 Z	wie 941 Z dazu 10 11	wie 941 Z	75.80

Amerik. Maße

931 AZ	$\frac{3}{8}$ $\frac{7}{16}$ $\frac{1}{2}$ $\frac{9}{16}$ $\frac{19}{32}$ $\frac{5}{8}$ $\frac{11}{16}$ $\frac{3}{4}$ $\frac{25}{32}$ $\frac{13}{16}$ $\frac{7}{8}$ $\frac{15}{16}$ $\frac{31}{32}$ 1 $\frac{11}{16}$ $\frac{11}{8}$ $\frac{13}{16}$ $\frac{11}{4}$	914-15 918	106.90
941 AZ	$\frac{3}{8}$ $\frac{7}{16}$ $\frac{1}{2}$ $\frac{9}{16}$ $\frac{19}{32}$ $\frac{5}{8}$ $\frac{11}{16}$ $\frac{3}{4}$ $\frac{25}{32}$ $\frac{13}{16}$ $\frac{7}{8}$	914-15 918	69.10

Engl. Maße

941 WZ	$\frac{3}{16}$ $\frac{1}{4}$ $\frac{5}{16}$ $\frac{3}{8}$ $\frac{7}{16}$ $\frac{1}{2}$ $\frac{9}{16}$ $\frac{5}{8}$ $\frac{11}{16}$ $\frac{3}{4}$	914-15 918	75.20
---------------	---	---------------	--------------

Amerik. u. engl. Maße

931 AWZ	$\frac{1}{2}$ $\frac{9}{16}$ $\frac{5}{8}$ $\frac{11}{16}$ $\frac{3}{4}$ $\frac{25}{32}$ $\frac{7}{8}$ $\frac{31}{32}$ 1 $\frac{11}{16}$ A $\frac{3}{16}$ $\frac{1}{4}$ $\frac{5}{16}$ $\frac{3}{8}$ $\frac{7}{16}$ $\frac{1}{2}$ $\frac{9}{16}$ $\frac{5}{8}$ W	914-15 918	103.20
----------------	--	---------------	---------------



**Steckschlüsselsätze
CHROM-VANADIUM**

950 Z

mit Zwölfkant-Einsätzen

1/2"



Metr. Maße

950 Z	13 14 16 17 19 22	913	27.40
Amerik. Maße			
950 AZ	$\frac{7}{16}$ $\frac{1}{2}$ $\frac{9}{16}$ $\frac{5}{8}$ $\frac{11}{16}$ $\frac{3}{4}$	913	26.30
Engl. Maße			
950 WZ	$\frac{3}{16}$ $\frac{1}{4}$ $\frac{5}{16}$ $\frac{3}{8}$ $\frac{7}{16}$ $\frac{1}{2}$	913	27.90



**Sechskant-Einsätze
CHROM-VANADIUM**

900

1/2"



Metr. Maße

Bestell-Nr. u. Größe	Einsatzhöhe mm	Pack- Norm	Verchromt Köpfe geschliffen
900			
10	38	10	
11	38	10	2.90
12	38	10	
13	38	10	
14	38	10	
15	38	10	3.20
16	38	10	
17	38	10	
18	38	10	3.80
19	38	10	
20	38	10	
21	38	10	4.20
22	41,5	10	
23	41,5	10	
24	44	10	4.60
25	44	10	
26	44	10	
27	47	10	
28	47	10	5.90
29	50	10	
30	50	10	
32	50	10	6.40



**Zwölfkant-Einsätze
CHROM-VANADIUM**

900 Z

1/2"



Metr. Maße

Bestell-Nr. u. Größe	Einsatzhöhe mm	Pack- Norm	Verchromt Köpfe geschliffen
900 Z			
10	38	10	
11	38	10	2.90
12	38	10	
13	38	10	
14	38	10	
15	38	10	3.20
16	38	10	
17	38	10	
18	38	10	3.80
19	38	10	
20	38	10	
21	38	10	4.20
22	41,5	10	
23	41,5	10	
24	44	10	4.60
25	44	10	
26	44	10	
27	47	10	
28	47	10	5.90
29	50	10	
30	50	10	
32	50	10	6.40
33	50	10	

HAZET Zwölfkant-Einsätze
CHROM-VANADIUM

900 Z

1/2"



Amerik. Maße

Bestell-Nr. u. Größe	Einsatzhöhe mm	Pack-Norm	Verchromt Köpfe geschliffen
900 AZ			
3/8	38	10	2.90
7/16	38	10	
1/2	38	10	
9/16	38	10	3.20
19/32	38	10	
5/8	38	10	
11/16	38	10	3.80
3/4	38	10	
25/32	38	10	4.20
13/16	38	10	
7/8	41,5	10	
15/16	44	10	4.60
31/32	44	10	
1	44	10	5.90
1 1/16	47	10	
1 1/8	47	10	
1 3/16	50	10	
1 1/4	50	10	6.40

Engl. Maße

Bestell-Nr. u. Größe	Einsatzhöhe mm	Pack-Norm	Verchromt Köpfe geschliffen
900 WZ			
3/16	38	10	2.90
1/4	38	10	
5/16	38	10	3.20
3/8	38	10	3.80
7/16	38	10	4.20
1/2	44	10	4.60
9/16	44	10	
5/8	47	10	5.90
11/16	50	10	
3/4	50	10	6.40

HAZET Zwölfkant-Einsätze
CHROM-VANADIUM

900 TZ

extra tief

1/2"



Metr. Maße

Bestell-Nr. u. Größe	Einsatzhöhe mm	Pack-Norm	Verchromt Köpfe geschliffen
900 TZ			
21	82	10	6.80
26	82	10	7.50
30	82	10	8.80

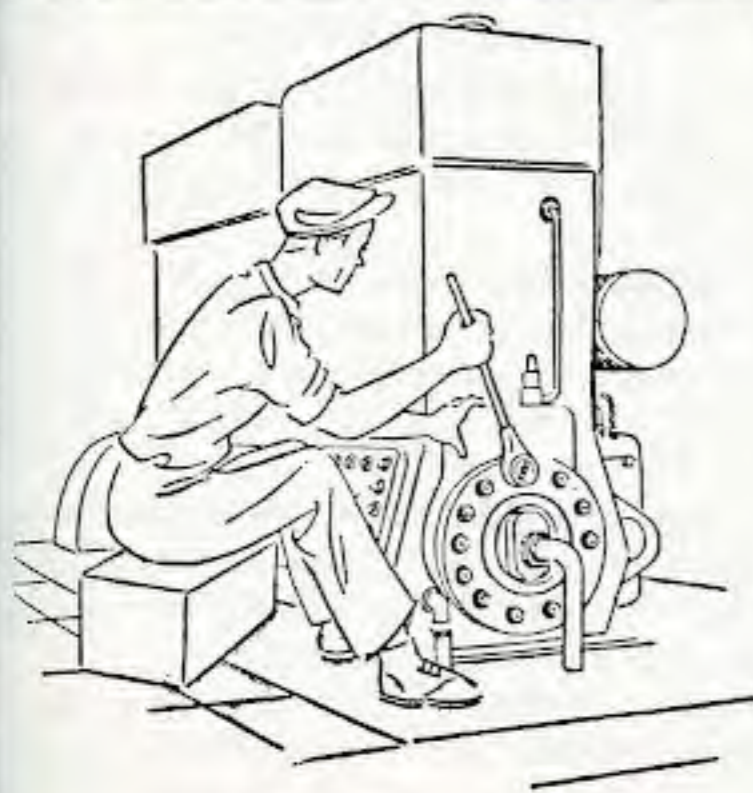

HAZET Betätigungswerkzeuge
CHROM-VANADIUM

911-980

1/2"



Bestell-Nr.	Bezeichnung	Pack-Norm	Verchr. Köpfe geschl.
911	Schwunggriff 16 1/2"	2	9.80
913	Winkelgriff 7 1/2"	5	3.90
914-15	Winkelgriff mit Gelenk 15"	5	17.20
914-18	Winkelgriff mit Gelenk 18"	5	19.10
915	T-Griff mit verschiebbarem Gleitstück 12"	5	7.50
916	Umschaltknarre 12", 28 Zähne, serienmäßig in Sortimenten	5	22.—
916 N	Umschaltknarre 10", 50 Zähne, nur auf Wunsch in Sortimenten	5	35.40
916 NE	kompl. Einsatzteil mit Drehknopf und Federring für Umschaltknarre 916 N	5	22.—
917	Verlängerung 5"	5	3.80
918	Verlängerung 10"	5	5.—
919	T-Griff-Schlüssel mit verschiebb. Griff, für VW, s. Seite 54	5	10.90
920	Universalgelenk 2 1/2" mit Innen-Arretierung	10	9.20
921	Innensechskant-Einsatz 8 mm für VW, s. Seite 54	10	5.40
922	dito 10 mm	10	5.70
958 RI	Reduzier-1/2" <input type="checkbox"/> massiv einstück <input type="checkbox"/> 3/8" <input type="checkbox"/> hohl	10	4.40
958 RII	Reduzier-3/8" <input type="checkbox"/> massiv einstück <input type="checkbox"/> 1/2" <input type="checkbox"/> hohl	10	5.—
962	Zündkerzenschlüssel-Einsatz mit Kardangelenk 21 mm	5	11.60
980-13	Schraubendreher-Eins. Klingebreite 13 mm Klingenstärke 2 mm	10	2.90
980-19	Schraubendreher-Eins. Klingebreite 19 mm Klingenstärke 3 mm	10	3.—
980-24	Schraubendreher-Eins. Klingebreite 24 mm Klingenstärke 4 mm	10	3.10

HAZET Sechskant-Einsätze für Innensechskant-schrauben
CHROM-VANADIUM

985

1/2"



Metr. Maße

Bestell-Nr. u. Größe	Einsatzhöhe mm	Pack-Norm	Verchromt Köpfe geschliffen
985			
5	38	10	4.30
6	38	10	4.40
8	38	10	4.60
10	40	10	4.80
12	40	10	5.—
14	40	10	5.50
17	42	10	5.90
19	42	10	6.40

HAZET Sechskant-Einsätze für Innensechskant-schrauben
CHROM-VANADIUM

985 K

1/2"

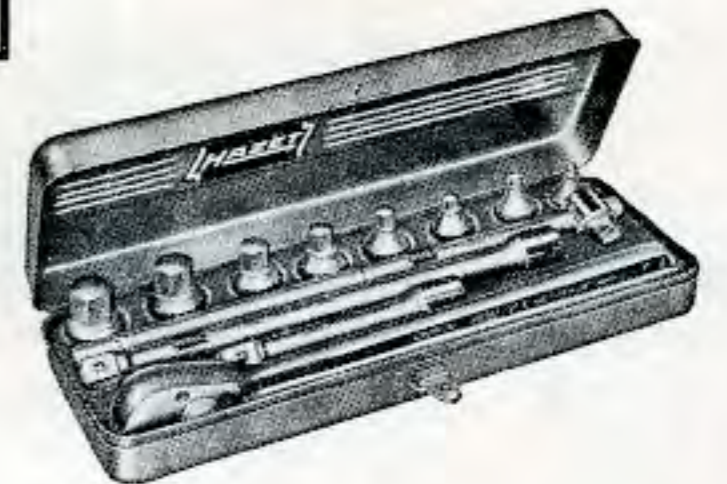

Satz mit Betätigungswerkzeugen im Kasten

Bestell-Nr.	Inhalt	Verchromt Köpfe geschliffen
985 K	Einsätze für Innensechskantschrauben 5 6 8 10 12 14 17 19 Betätigungswerkzeuge 915 916 917 918	91.80

HAZET Schraubendreher-Einsätze
CHROM-VANADIUM

990

1/2"

sehr genauer Paßsitz für XZN-Schrauben



Bestell-Nr.	für Schrauben M	Einsatzhöhe mm	Pack-Norm	Glanz-vernickelt
990-5	5	52	10	8.—
6	6	52	10	8.—
8	8	53	10	8.—
8 Lg.	8	100	10	8.60
10	10	53	10	8.40
12	12	55	10	9.20

Zuordnung der XZN-Schrauben für Opel-Fahrzeuge siehe Seite 47



**Steckschlüsselsätze
CHROM-VANADIUM**

**1000-
1002**

mit Sechskant-Einsätzen

3/4"



Metr. Maße

Bestell-Nr.	Inhalt		Verchromt Köpfe geschliffen
	Einsätze 6-kant	Betätigungs- Werkzeuge	
1000	22 24 27 30 32 36 38 41 46 50	1014 1015 1016 1017-8 1018 1020	250.—
1002	wie 1000 zusätzlich 55 60	wie 1000	301.30



**Steckschlüsselsätze
CHROM-VANADIUM**

**1000 Z-
1003 Z**

mit Zwölfkant-Einsätzen

3/4"

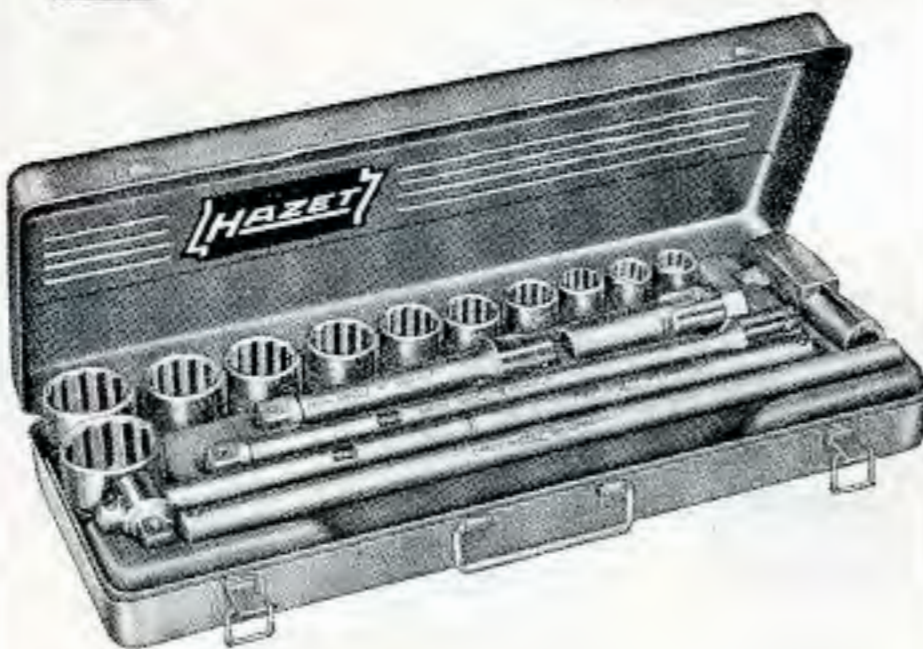

Metr. Maße

Bestell-Nr.	Inhalt		Verchromt Köpfe geschliffen
	Einsätze 12-kant	Betätigungs- Werkzeuge	
1000 Z	22 24 27 30 32 36 38 41 46 50	1014 1015 1016 1017-8 1018 1020	250.—
1001 Z	wie 1000 Z zusätzlich 12-kant- Einsatz 19	wie 1000 Z	254.90
1002 Z	wie 1000 Z zusätzlich 6-kant- Einsätze 55 60	wie 1000 Z	301.30
1003 Z	wie 1002 Z zusätzlich 12-kant- Einsatz 19	wie 1002 Z	306.20



**Steckschlüsselsätze
CHROM-VANADIUM**

**1000 Z-
1001 Z**

mit Zwölfkant-Einsätzen

3/4"



Amerik. Maße

Bestell-Nr.	Inhalt		Verchromt Köpfe geschliffen
	Einsätze 12-kant	Betätigungs- Werkzeuge	
1000 AZ	7/8 15/16 1 1 1/16 1 1/8 1 3/16 1 1/4 1 5/16 1 3/8 1 7/16 1 1/2 1 5/8 1 3/4 1 13/16 1 7/8 2	1014 1015 1016 1017-8 1018 1020	308.—
1001 AZ	wie 1000 AZ zusätzlich 12-kant- Einsatz 3/4	wie 1000 AZ	312.90

Engl. Maße

1000 WZ	1/2 9/16 5/8 11/16 3/4 13/16 7/8 1 1 1/8	1014 1015 1016 1017-8 1018 1020	235.40
----------------	--	--	---------------



**Sechskant-Einsätze
CHROM-VANADIUM**

1000

mit Stiftsicherung

3/4"



Metr. Maße

Bestell-Nr. u. Größe	Einsatzhöhe mm	Pack- Norm	Verchromt Köpfe geschliffen
1000			
22	52	10	4.90
24	52	10	5.50
27	52	10	6.70
30	55	10	8.60
32	58	10	9.20
36	61,5	10	9.70
38	65	10	10.20
41	68,5	10	11.70
46	73	10	13.20
50	76	10	14.10
55	82	10	22.90
60	88	10	28.40



**Zwölfkant-Einsätze
CHROM-VANADIUM**

1000 Z

mit Stiftsicherung

3/4"



Metr. Maße

Bestell-Nr. u. Größe	Einsatzhöhe mm	Pack- Norm	Verchromt Köpfe geschliffen
1000 Z			
19	52	10	4.90
22	52	10	4.90
23	52	10	4.90
24	52	10	5.50
25	52	10	5.50
26	52	10	5.50
27	52	10	6.70
28	53	10	6.70
29	55	10	8.60
30	55	10	8.60
32	58	10	9.20
33	58	10	9.20
35	61,5	10	9.70
36	61,5	10	9.70
38	65	10	10.20
41	68,5	10	11.70
42	70	10	11.70
46	73	10	13.20
50	76	10	14.10

Amerik. Maße

1000 AZ			
3/4	52	10	4.90
7/8	52	10	4.90
15/16	52	10	5.50
31/32	52	10	5.50
1	52	10	5.50
1 1/16	52	10	6.70
1 1/8	55	10	8.60
1 3/16	55	10	8.60
1 1/4	58	10	9.20
1 5/16	58	10	9.20
1 3/8	61,5	10	9.70
1 7/16	63	10	9.70
1 1/2	65	10	10.20
1 9/16	68,5	10	11.70
1 5/8	68,5	10	11.70
1 11/16	70	10	11.70
1 3/4	70	10	11.70
1 13/16	73	10	13.20
1 7/8	75	10	13.20
2	79	10	14.10

Engl. Maße

1000 WZ			
1/2	52	10	4.90
9/16	52	10	5.50
5/8	53	10	6.70
11/16	55	10	8.60
3/4	58	10	9.20
13/16	61,5	10	9.70
7/8	65	10	10.20
1	70	10	11.70
1 1/8	75	10	13.20

**Einsätze und Betätigungs-Werkzeuge
mit Stiftsicherung**

Die Stiftsicherung verhindert ein Abrutschen der Einsätze. Dadurch werden Betätigungs-Werkzeuge und Einsätze praktisch zu einem Werkzeug.

Die Einsätze haben eine breite, griffige Rändelung und sind in der Höhe bzw. Tiefe abgestuft. Die Verlängerungen sind am Kopfende durchgehbohrt. Dadurch sind sie mittels Stecker auf feste T-Griffe verwendbar.

Der Schiebegriff ist in der Mitte mit einer Einrastrinne versehen, um das Gleitstück festzuhalten. Eine Haltevorrichtung am Ende des Schiebegriffs verhindert ein Verkanten.

Die Knarre in ihrer verstärkten Konstruktion kann wahlweise auf Rechts- oder Linksgang eingestellt werden. Sie ist stabil und unverwundlich.



Betätigungswerkzeuge CHROM-VANADIUM

1000

mit Stiftsicherung

3/4"

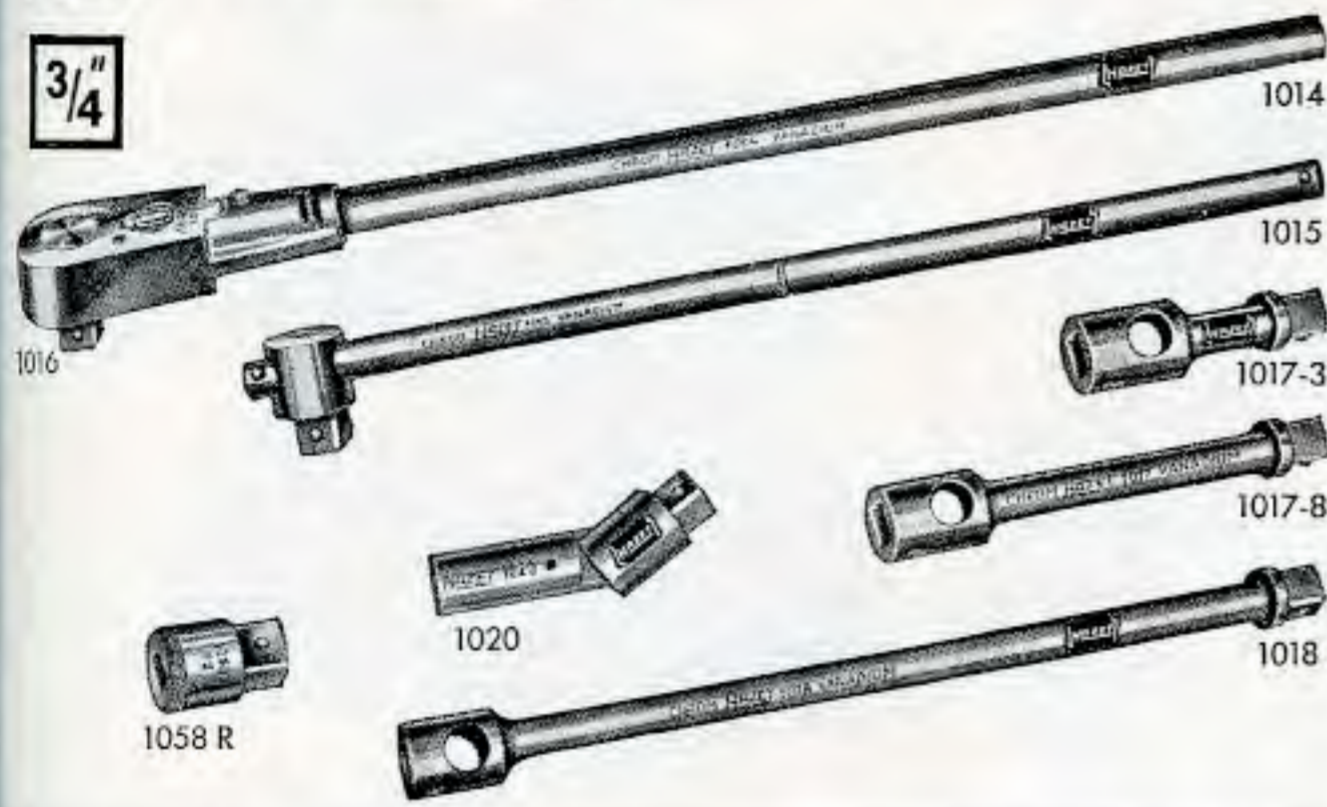

Bestell-Nr.	Bezeichnung	Pack-Norm	Verchromt Köpfe geschliffen
1014	Stecker 20" 20 mm ø	5	12.60
1015	Schiebegriff 20" 20 mm ø	2	20.90
1016	Knarrenkopf 6"	2	42.60
1017-3	Verlängerung 3" 20 mm ø	2	7.50
1017-8	Verlängerung 8 1/2" 20 mm ø	2	10.20
1018	Verlängerung 17" 20 mm ø	2	13.60
1020	Gelenkstück 5" 38 mm ø	2	19.40
1056	Einsatz 36 mm für VW, s. Seite 54	5	9.70
1058 RI	Reduziereinsatz 1/2" □ massiv	5	6.40
	3/4" □ hohl		
1058 RII	Reduziereinsatz 3/4" □ massiv	5	5.50
	1/2" □ hohl		



Werkzeugausrüstungen CHROM-VANADIUM

1100

für Traktoren

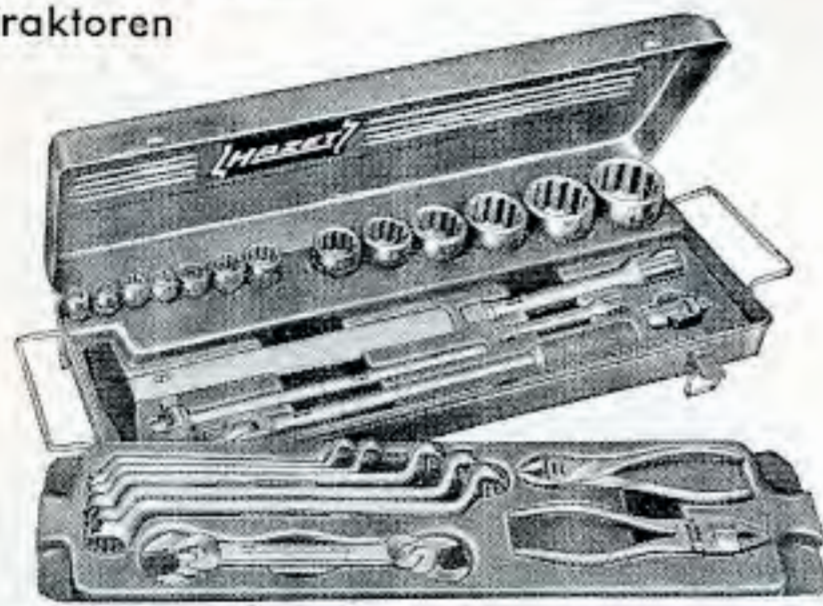

in hausfarbenen HAZET-Metallkästen

Kastengröße:
575 x 220 x 95 mm

Bestell-Nr.	Sortimente einschl. Metallkasten	Gewicht kg	Verchromt
1100	Metr. 35teilig	14	299.—
1100 A	Amerik. 35teilig	14	299.—

INHALTSÜBERSICHT

Nr.	Bezeichnung	Metr. 35teilig HAZET 1100	Amerik. 35teilig HAZET 1100 A
450	Gabelschlüssel	12 x 13 14 x 15 20 x 22	7/16 x 1/2 9/16 x 5/8 3/4 x 7/8
630	Ringschlüssel, gekröpft	10 x 11 12 x 13 16 x 17 18 x 19 20 x 22	3/8 x 7/16 1/2 x 9/16 5/8 x 11/16 3/4 x 25/32 13/16 x 7/8
900Z	Zwölfkant-Einsätze 1/2" □ Antrieb	13 14 16 17 19 22 25	1/2 9/16 5/8 11/16 3/4 7/8 1
1000Z	Zwölfkant-Einsätze 3/4" □ Antrieb	30 32 36 41 46 50	1 1/8 1 1/4 1 1/2 1 5/8 1 13/16 2
2140	Hammer	500 g	—
2141	Engl. Hammer	—	1 lbs.

ALLE SORTIMENTE (1100-1100 A) enthalten außerdem:

731-5	Meißel 150 x 15	917	Verlängerung 5"
746-1	Körner 120 x 10	920	Universalgelenk
760-3	Universalzange 9 1/2"		Betätigungswerkzeuge
830-1	Schraubendreher 75 x 5		3/4" □ Antrieb
830-9	dito 150 x 8	1015	Schiebegriff 20"
	Betätigungswerkzeuge	1017-8	Verlängerung 8 1/2"
	1/2" □ Antrieb		
914-15	Winkelgriff 15"	1801-2	Seitenschneider 6 1/2"
915	T-Griff 12"	1850-3	Kombizange 7"



Werkzeugausrüstungen CHROM-VANADIUM

1100-1

für Traktoren

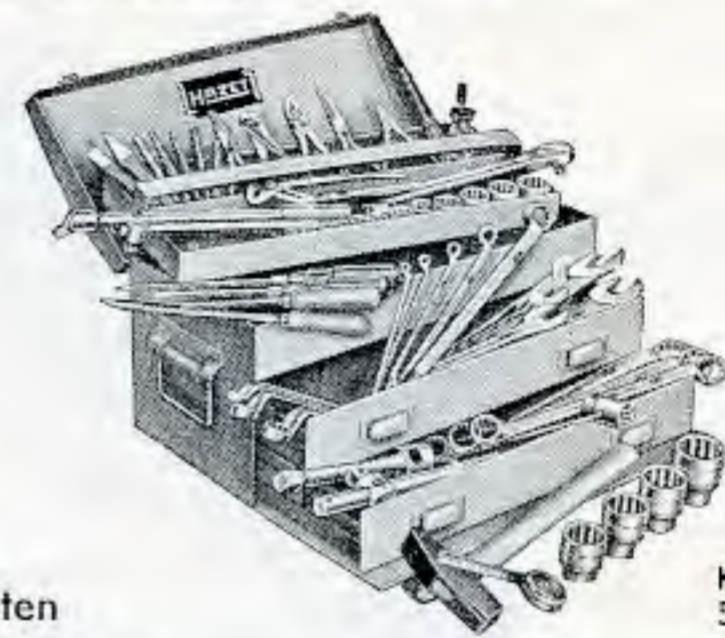

in hausfarbenen
HAZET-Metallkästen

Kastengröße:
545 x 260 x 290 mm

Bestell-Nr.	Sortimente einschl. Werkzeugkasten	Gewicht kg	Verchromt
1100-1	Metr. 74teilig	36	722.—
1100-1 A	Amerik. 74teilig	36	713.—
1100-1 W	Engl. 70teilig	36	722.—

INHALTSÜBERSICHT

Nr.	Bezeichnung	Metr. 74teilig HAZET 1100-1	Amerik. 74teilig HAZET 1100-1 A	Engl. 70teilig HAZET 1100-1 W
430	Steckschlüssel, massiv	8 x 9 10 x 11 12 x 13	—	—
450	Gabelschlüssel	6 x 7 8 x 9 9 x 10 10 x 11 14 x 15 14 x 17 17 x 19 19 x 22 22 x 24 24 x 27 30 x 36	1/4 x 5/16 5/16 x 3/8 3/8 x 7/16 1/2 x 9/16 9/16 x 5/8 5/8 x 11/16 5/8 x 3/4 3/4 x 25/32 3/4 x 7/8 15/16 x 1 1 x 1 1/8 1 1/16 x 1 1/4	1/16 x 3/32 3/32 x 1/8 1/8 x 3/16 3/16 x 1/4 1/4 x 5/16 5/16 x 3/8 3/8 x 7/16 7/16 x 1/2 1/2 x 9/16 9/16 x 5/8 5/8 x 3/4 3/4 x 7/8
630	Ringschlüssel, gekröpft	6 x 7 8 x 9 10 x 11 12 x 13 14 x 15 16 x 17 18 x 19 20 x 22 21 x 23 24 x 26 25 x 28 27 x 30 32 x 36	1/4 x 5/16 3/8 x 7/16 1/2 x 9/16 19/32 x 11/16 5/8 x 11/16 5/8 x 3/4 3/4 x 25/32 13/16 x 7/8 15/16 x 1 1 x 1 1/8 1 1/4 x 1 7/16	1/8 x 3/16 3/16 x 1/4 1/4 x 5/16 5/16 x 3/8 3/8 x 7/16 7/16 x 1/2 1/2 x 9/16 9/16 x 5/8 5/8 x 3/4 3/4 x 7/8 7/8 x 1
900Z	Zwölfkant-Einsätze 1/2" □ Antrieb	10 11 14 17 19 22 24 27 30 32	3/8 7/16 1/2 9/16 19/32 5/8 3/4 7/8 15/16 1 1 1/16 1 1/8 1 1/4	3/16 1/4 5/16 3/8 7/16 1/2 9/16 5/8 1 1/16 3/4
1000Z	Zwölfkant-Einsätze 3/4" □ Antrieb	36 38 41 46	1 7/16 1 1/2 1 5/8 1 13/16	13/16 7/8 1 1 1/8
2140	Hämmer	300 1000g	—	—
2141	Hämmer	—	3/4 2 lbs.	3/4 2 lbs.
2147	Fühlerlehre	metr.	amerik.	metr.

ALLE SORTIMENTE (1100-1-1100-1A-1100-1W) enthalten außerdem:

650-20	Reifenheber 20", 2 Stück	916	Umschaltknarre 12"
730-3	Flachmeißel 150 x 18	917	Verlängerung 5"
740-3	Kreuzmeißel 150 x 8	920	Universalgelenk
745-13	Durchschläger 120 x 5	980-13	Schraubendreher-Einsatz 13 x 2
745-15	dito 120 x 7		Betätigungswerkzeuge
745-17	dito 120 x 9		3/4" □ Antrieb
746-1	Körner 120 x 10	1015	Schiebegriff 20"
760-3	Universalzange 9 1/2"	1017-8	Verlängerung 8 1/2"
815-2	Schraubendreher 125 x 7	1801-2	Seitenschneider 6 1/2"
815-3	dito 150 x 9		Spezialzangen für
815-5	dito 200 x 11		Seegersicherungen
820-3	Schaber 200		innen, abgewinkelt
832-2	Schraubendreher 80 x 3	1846b-2	außen, gerade
	Betätigungswerkzeuge	1846c-2	Kombizange 7"
	1/2" □ Antrieb	1850-3	Magnetsucher
911	Schwunggriff 16 1/2"	1976	Leichtmetallhammer
914-15	Winkelgriff 15"	2142	Rollbandmaß 2 m
915	T-Griff 12"	2154	



Werkzeugsatz CHROM-VANADIUM

für FORDSON-Traktoren

1102

in Plastic-Tasche

1102 A	Amerik. 18teilig	106.70
--------	------------------	--------



**Werkzeugsätze
CHROM-VANADIUM
kombiniert**

**1130-
1135**

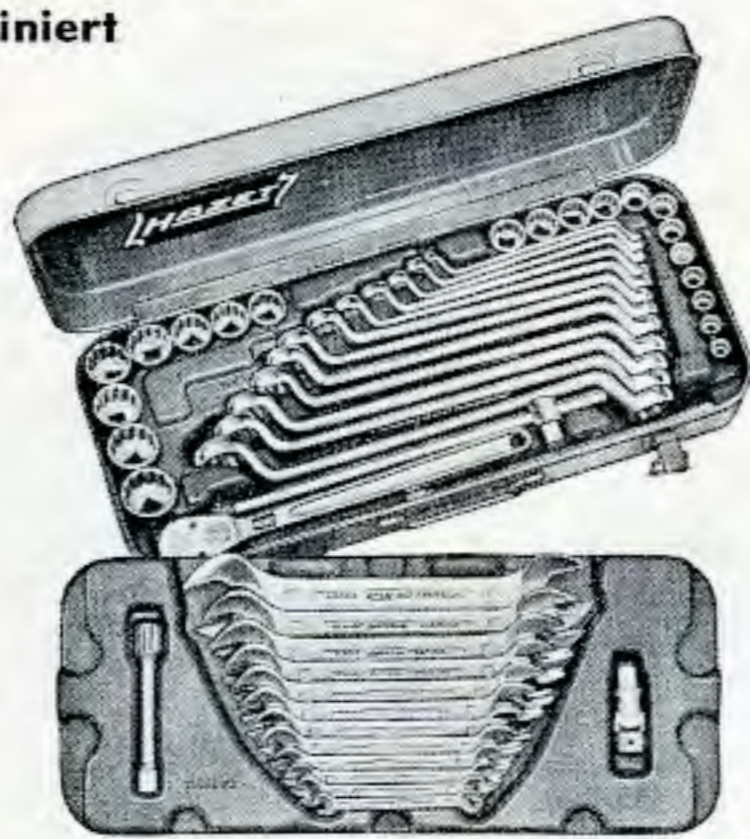

in hausfarbenen
HAZET-Metallkästen

Bestell-Nr.	Sortimente einschl. Metallkasten	Gewicht kg	Verchromt
1130 M	Metr. 49teilig	12	317.—
1130 A	Amerik. 39teilig	10	259.—
1130 W	Engl. 31teilig	9,5	233.—
1135 M	Metr. 34teilig	6,9	203.—
1135 A	Amerik. 29teilig	7,1	196.—
1135 W	Engl. 24teilig	6,3	173.—

INHALTSÜBERSICHT

Nr.	Bezeichnung	Metr. 49teilig HAZET 1130M			Amerik. 39teilig HAZET 1130A			Engl. 31teilig HAZET 1130W					
		6x7	8x9	10x11	12x13	14x15	16x17	18x19	20x22	21x23	24x26	25x28	27x32
450	Gabelschlüssel	6x7	8x9	10x11	12x13	14x15	16x17	18x19	20x22	21x23	24x26	25x28	27x32
630	Ringschlüssel, gekröpft	6x7	8x9	10x11	12x13	14x15	16x17	18x19	20x22	21x23	24x26	25x28	27x32
900Z	Zwölfkant-Einsätze 1/2" □ Antrieb	10	11	12	13	14	15	16	17	18	19	20	21

Nr.	Bezeichnung	Metr. 34teilig HAZET 1135M			Amerik. 29teilig HAZET 1135A			Engl. 24teilig HAZET 1135W					
		6x7	8x9	10x11	12x13	14x15	16x17	18x19	20x22	21x23	24x26	25x28	27x32
450	Gabelschlüssel	6x7	8x9	10x11	12x13	14x15	16x17	18x19	20x22	21x23	24x26	25x28	27x32
630	Ringschlüssel, gekröpft	6x7	8x9	10x11	12x13	14x15	16x17	18x19	20x22	21x23	24x26	25x28	27x32
900Z	Zwölfkant-Einsätze 1/2" □ Antrieb	10	11	12	13	14	15	16	17	18	19	20	21

ALLE SORTIMENTE (1130M - 1130A - 1130W)
(1135M - 1135A - 1135W) enthalten außerdem:

Betätigungswerkzeuge 1/2" □ Antrieb	917 Verlängerung 5"
915 T-Griff 12"	918 Verlängerung 10"
916 Umschaltknarre 12"	920 Universalgelenk



**Werkzeugsatz
CHROM-VANADIUM
kombiniert**

1140



im hausfarbenen
HAZET-Metallkasten

Kastengröße: 495x220x90 mm

Bestell-Nr.	Inhalt	Verchromt
450/6 A III	Gabelschlüsselsatz, 6teilig 3/8 x 7/16 - 15/16 x 1	
450 W	Gabelschlüssel 1/8 x 3/16 1/4 x 5/16 3/8 x 7/16 1/2 x 9/16 5/8 x 3/4	
630/6 A	Ringschlüsselsatz, gekröpft, 6teilig 3/8 x 7/16 - 15/16 x 1	
630 W	Ringschlüssel, gekröpft 1/8 x 3/16 1/4 x 5/16 3/8 x 7/16 1/2 x 9/16 5/8 x 3/4	
900 AZ	Zwölfkant-Einsätze 1/2" □ Antrieb 3/8 7/16 1/2 9/16 5/8 11/16 3/4 25/32 7/8 15/16 1	
900 WZ	Zwölfkant-Einsätze 1/2" □ Antrieb 3/16 1/4 5/16 3/8 7/16 1/2 9/16 5/8 11/16 3/4	
	Betätigungswerkzeuge 1/2" □ Antrieb	
911	Schwunggriff 16 1/2"	
915	T-Griff 12"	
916	Umschaltknarre 12"	
917	Verlängerung 5"	
918	Verlängerung 10"	
920	Universalgelenk	
1140 AW	49teilig	328.—



**Werkzeugsatz
CHROM-VANADIUM
kombiniert**

1150



im hausfarbenen
HAZET-Metallkasten

Kastengröße: 575 x 220 x 85 mm

179-8	Schraubenschlüssel 8", verstellbar	
450/12	Gabelschlüsselsatz, 12teilig 6 x 7 - 27 x 32	
630/12	Ringschlüsselsatz, gekröpft, 12teil. 6 x 7 - 27 x 32	
760-3	Universalzange 9 1/2"	
830-3	Schraubendreher 100 x 6	
830-6	dito 125 x 7	
830-9	dito 150 x 8	
834-1	Schraubendreher für Vergaser, 25 x 5	
1850-3	Kombizange 7"	
2140-3	Schlosserhammer 300 g	
1150	32teilig	252.—

HAZET Kraftseitenschneider
SPEZIALSTAHL

1801



Bestell-Nr.	mm/Zoll	Pack-Norm	Hochglanz verchromt
1801-0	130 5	1	11.40
1	145 6	1	11.90
2	165 6 1/2	1	14.50
3	200 8	1	18.40

mit Handschutz-Isolierung 10 000 Volt



1801-00	130 5	1	14.10
11	145 6	1	15.10
22	165 6 1/2	1	17.90
33	200 8	1	22.20

HAZET Kraftseitenschneider
CHROM-VANADIUM

1802

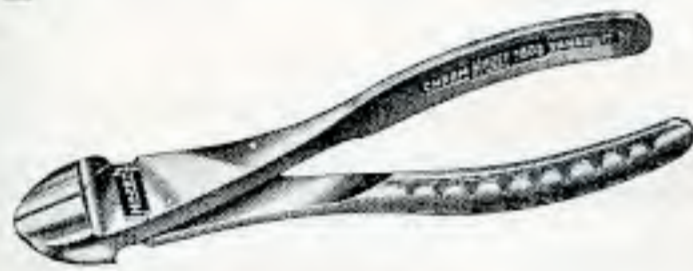

1802-1	145 6	1	14.40
2	170 7	1	16.20
3	200 8	1	21.20

mit Handschutz-Isolierung 10 000 Volt

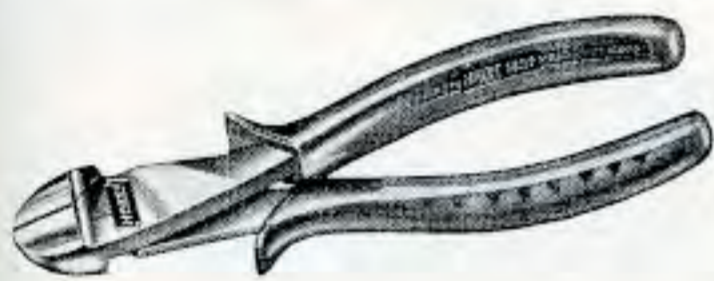

1802-11	145 6	1	17.40
22	170 7	1	19.40
33	200 8	1	25.20

HAZET Seitenschneider
SPEZIALSTAHL

1803

schwedische Form



1803-0	115 4 1/2	1	9.20
1	130 5	1	10.60
2	145 6	1	11.80
3	160 6 1/2	1	13.10

mit Handschutz-Isolierung 10 000 Volt



1803-00	115 4 1/2	1	11.40
11	130 5	1	13.10
22	145 6	1	14.50
33	160 6 1/2	1	16.30

HAZET Hebelseitenschneider
SPEZIALSTAHL

1805

blau lackiert



Bestell-Nr.	mm/Zoll	Pack-Norm	Schneide poliert
1805-2	185 7	1	16.90
3	210 8	1	18.80

HAZET Hebelvorschneider
SPEZIALSTAHL

1806

blau lackiert



1806-1	150 6	1	15.20
2	185 7	1	16.90
3	210 8	1	18.80
4	235 9	1	24.—

HAZET Kraftvorschneider
SPEZIALSTAHL

1807

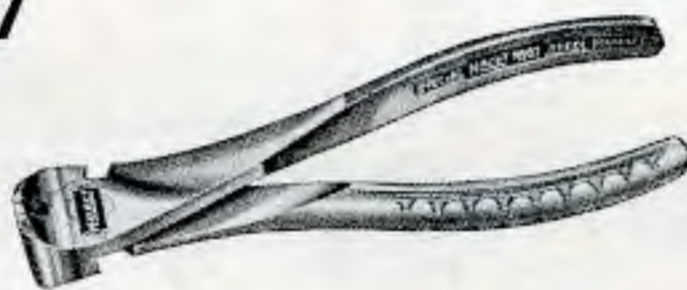

Bestell-Nr.	mm/Zoll	Pack-Norm	Hochglanz verchromt
1807-0	130 5	1	13.10
1	160 6 1/2	1	15.90
2	200 8	1	21.80

mit Handschutz-Isolierung 10 000 Volt



1807-00	130 5	1	15.80
11	160 6 1/2	1	18.80
22	200 8	1	25.20

HAZET Flachzangen
SPEZIALSTAHL

1811



1811-1	120 5	1	7.—
2	140 5 1/2	1	8.—
3	160 6 1/2	1	8.70
4	180 7	1	9.70

mit Handschutz-Isolierung 10 000 Volt



1811-11	120 5	1	9.50
22	140 5 1/2	1	10.70
33	160 6 1/2	1	11.40
44	180 7	1	12.80

HAZET Langbeckzangen
SPEZIALSTAHL

1815

flach



Bestell-Nr.	mm/Zoll	Pack-Norm	Hochglanz verchromt
1815-1	130 5	1	8.—
2	160 6 1/2	1	9.30

mit Handschutz-Isolierung 10 000 Volt



1815-11	130 5	1	10.50
22	160 6 1/2	1	12.40

HAZET Rundzangen
SPEZIALSTAHL

1821



1821-1	120 5	1	7.—
2	140 5 1/2	1	8.—
3	160 6 1/2	1	8.70
4	180 7	1	9.70

mit Handschutz-Isolierung 10 000 Volt

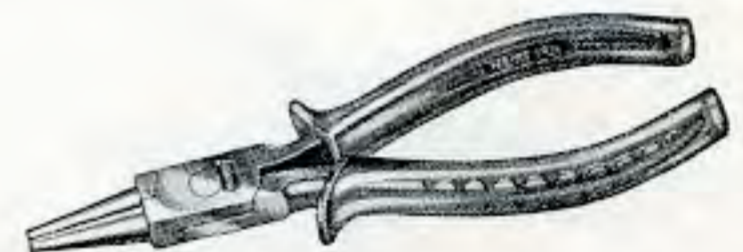

1821-11	120 5	1	9.50
22	140 5 1/2	1	10.70
33	160 6 1/2	1	11.40
44	180 7	1	12.80

HAZET Langbeckzangen
SPEZIALSTAHL

1825

rund



1825-1	130 5	1	8.—
2	160 6 1/2	1	9.30

mit Handschutz-Isolierung 10 000 Volt



1825-11	130 5	1	10.50
22	160 6 1/2	1	12.40



Long-Grip-Zangen
CHROM-VANADIUM

1841

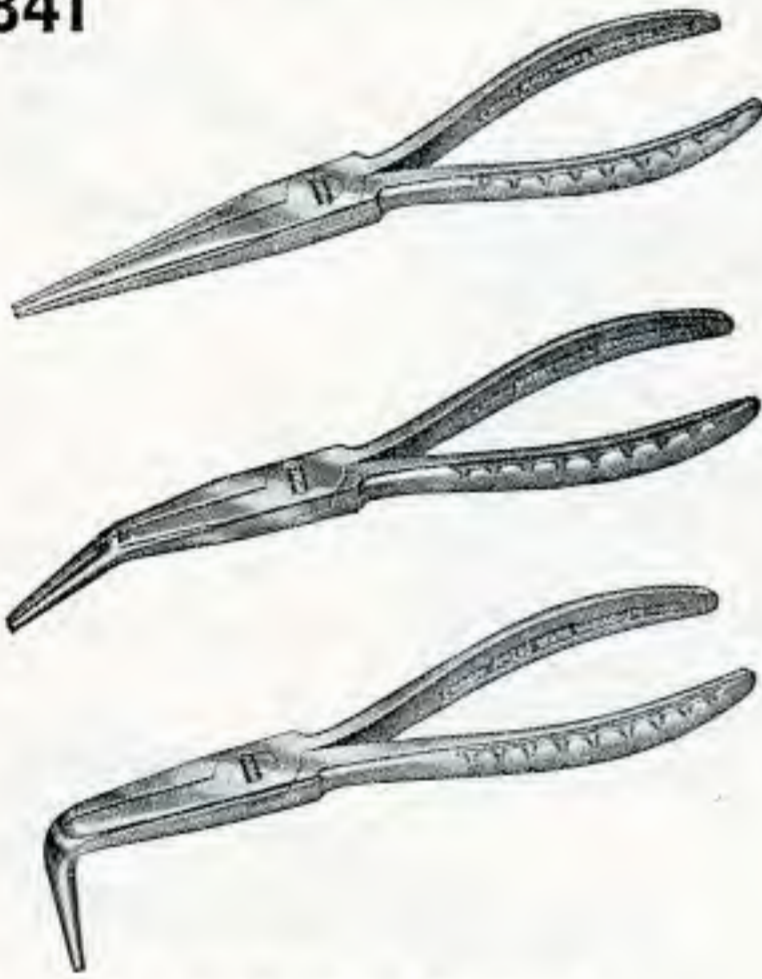

mit geraden ovalspitzen Backen

Bestell-Nr.	mm/Zoll	Pack-Norm	Hochglanz verchromt
1841 a - 1	145 6	1	11.20
2	170 7	1	12.30
3	210 8	1	14.80

stumpfwinklig gebogen (35°)

1841 b - 3	210 8	1	15.60
------------	-------	---	-------

rechtwinklig gebogen

1841 c - 3	210 8	1	15.60
------------	-------	---	-------

mit Handschutz-Isolierung 10 000 Volt

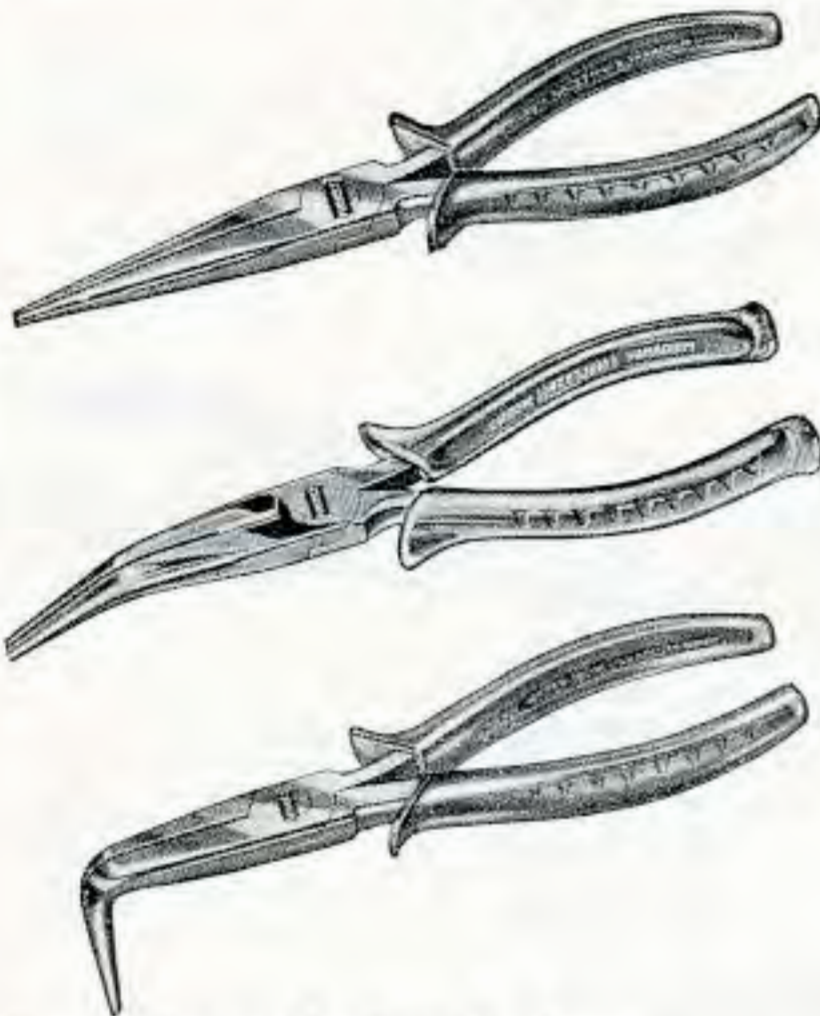

mit geraden ovalspitzen Backen

1841 a - 11	145 6	1	13.80
22	170 7	1	15.—
33	210 8	1	17.80

stumpfwinklig gebogen (35°)

1841 b - 33	210 8	1	18.60
-------------	-------	---	-------

rechtwinklig gebogen

1841 c - 33	210 8	1	18.60
-------------	-------	---	-------



Splintenausziehzange
CHROM-VANADIUM

1842

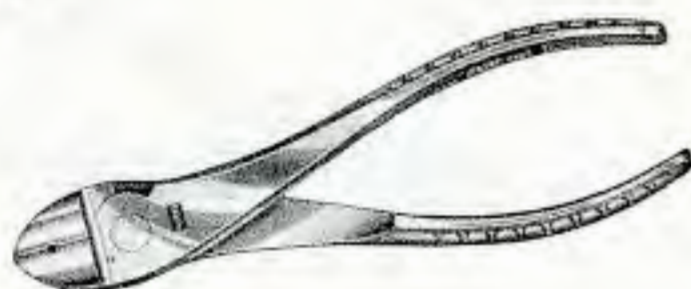

1842	170 7	1	16.70
------	-------	---	-------



Spezialzangen
CHROM-VANADIUM

1846

für Seegersicherungen

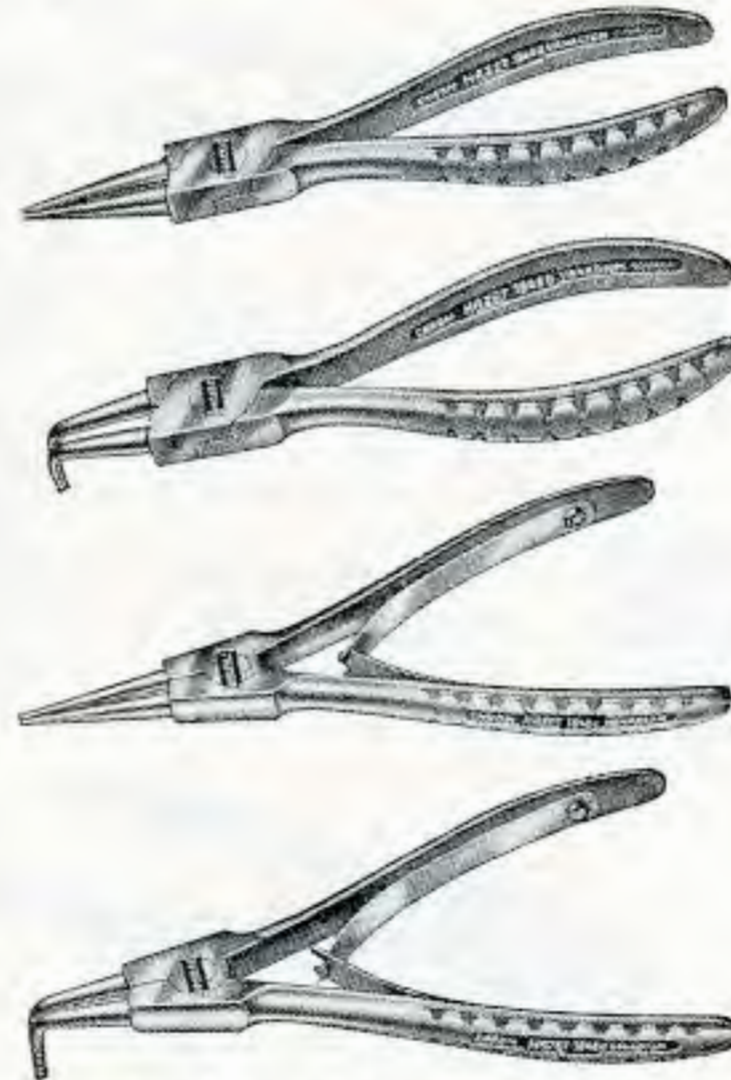

gerade - für Innensicherungen

Bestell-Nr.	mm/Zoll	Pack-Norm	Hochglanz verchromt
1846 a - 1	130 5	1	12.10
2	170 7	1	14.30
3	220 8 1/2	1	19.—

abgewinkelt - für Innensicherungen

1846 b - 1	130 5	1	13.80
2	170 7	1	15.90
3	220 8 1/2	1	20.20

gerade - für Außensicherungen

1846 c - 1	130 5	1	13.20
2	170 7	1	14.50
3	220 8 1/2	1	18.70

abgewinkelt - für Außensicherungen

1846 d - 1	130 5	1	13.90
2	170 7	1	16.20
3	220 8 1/2	1	20.20



Batterie- und Mutterzange
CHROM-VANADIUM

1848



1848	200 8	1	12.10
------	-------	---	-------



Kombinationszangen
SPEZIALSTAHL

1850



Bestell-Nr.	mm/Zoll	Pack-Norm	Hochglanz verchromt	Verchromt
1850 - 1	120 5	1	8.—	7.50
2	160 6 1/2	1	8.70	7.90
3	180 7	1	9.90	9.10
4	210 8	1	11.40	10.60

mit Handschutz-Isolierung 10 000 Volt

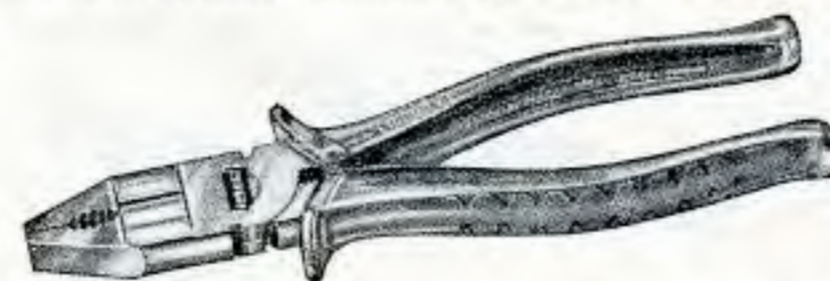

1850 - 11	120 5	1	10.20	9.70
22	160 6 1/2	1	11.30	10.60
33	180 7	1	13.—	12.10
44	210 8	1	14.70	13.90



Universal-Figuerschere
CHROM-VANADIUM

1852

mit Feder

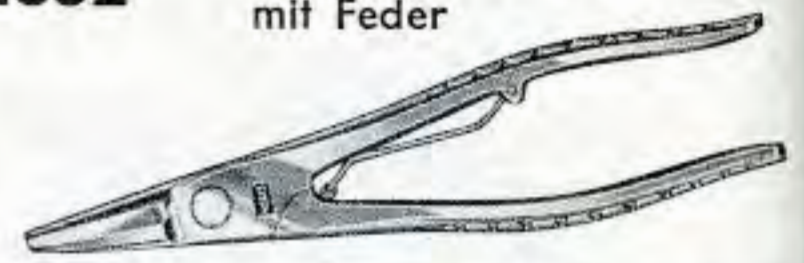

Bestell-Nr.	mm/Zoll	Pack-Norm	Hochglanz verchromt	Verchromt
1852	210 8	1	20.50	18.70



Kombinationszangen
CHROM-VANADIUM

1855



Bestell-Nr.	mm/Zoll	Pack-Norm	Hochglanz verchromt
1855 - 1	160 6 1/2	1	15.40
2	180 7	1	16.90
3	210 8	1	19.—

mit Handschutz-Isolierung 10 000 Volt



1855 - 11	160 6 1/2	1	18.50
22	180 7	1	20.40
33	210 8	1	22.90



Abisolierzangen
SPEZIALSTAHL

1860

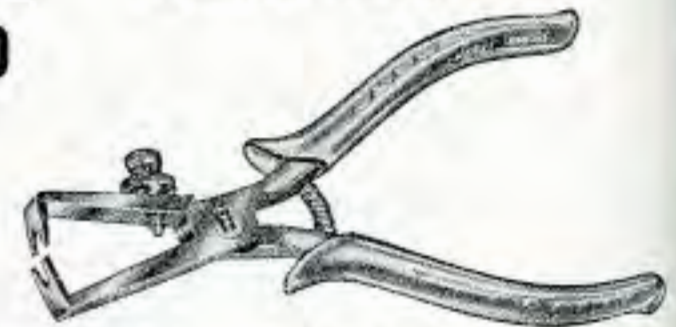

mit Stellschraube und Feder

Bestell-Nr.	mm/Zoll	Pack-Norm	Verchromt Köpfe poliert
1860 - 1	150 6	1	14.10

mit Handschutz-Isolierung 10 000 Volt

1860 - 11	150 6	1	16.30
-----------	-------	---	-------



Zangen
CHROM-VANADIUM

1800



Satz auf Verkaufstafel

Bestell-Nr.	Inhalt	Preis
je 2 Zangen:		
759	760-1 760-3	
760-33	1801-2 1803-2	
1807-1	1841 a-3 1841 b-3	
1841 c-3	1841 b-33 1846 a-2	
1846 b-2	1846 c-2 1846 d-2	
1850-3	1850-33 1852	
VT 1800 - 1	36 teilig	521.—



**Ausbeulwerkzeugsätze
SPEZIALSTAHL**

1900
1905



Kastengröße:
575 x 220 x 65 mm

in hausfarbenen HAZET-Metallkästen

Best.-Nr.	Inhalt	Preis
1911	Handfaust	
1912	Handfaust	
1913	Handfaust	
1933a	Kotflügel-Biegezange	
1935	Ausbeul- u. Schlichthammer	
1938K	Spann- u. Schlichthammer	
1940	Schlicht- u. Treibhammer	
1900	Kleiner Ausbeulsatz, 7tlg.	155.—
1911	Handfaust	
1912	Handfaust	
1913	Handfaust	
1928	Löffeleisen	
1931	Biegeeisen	
1934	Karosseriefeile	
1935	Ausbeul- u. Schlichthammer	
1938K	Spann- u. Schlichthammer	
1940	Schlicht- u. Treibhammer	
1948	Gummi- und Handhammer, kombiniert	
1905	Standard-Ausbeulsatz, 10tlg.	235.—



**Ausbeulwerkzeugsatz
SPEZIALSTAHL**

1910



Tafelgröße: 870 x 635 mm

auf hausfarbener HAZET-Metallwandtafel

Best.-Nr.	Inhalt	Preis
1911	Handfaust	
1912	Handfaust	
1913	Handfaust	
1928	Löffeleisen	
1929	Ausbeul-Hebeleisen	
1930	Ausbeul-Hebeleisen	
1934	Karosseriefeile	
1935	Ausbeul- u. Schlichthammer	
1938K	Spann- u. Schlichthammer	
1940	Schlicht- u. Treibhammer	
1941	dito	
1942	Schlicht- u. Spitzhammer	
1948	Gummi- und Handhammer, kombiniert	
1950-4	Plastic-Hammer, 35 mm	
1950-5	Plastic-Hammer, 40 mm	
1910 T	15teilig	352.—



**Ausbeulwerkzeugsätze
SPEZIALSTAHL**

1910

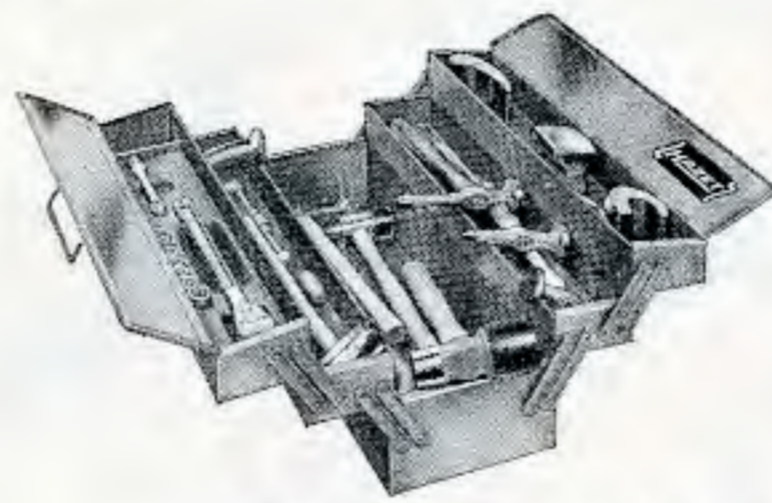

Kastengröße: 540 x 205 x 215 mm

in hausfarbenen HAZET-Metallkästen

Best.-Nr.	Inhalt	Preis
	wie 1910 T, jedoch zusätzlich	
900 Z	Zwölfkanteinsätze 1/2" □ Antrieb	
	10 11 12 13 14 17 19	
916	Umschaltknarre 12"	
917	Verlängerung 5"	
1910 K	24teilig	407.—
	wie vor, jedoch mit Zwölfkanteinsätzen amerik. Maße	
	3/8 7/16 1/2 9/16 5/8 11/16 3/4	
1910 KA	24teilig	407.—
	wie vor, jedoch mit Zwölfkanteinsätzen engl. Maße	
	3/16 1/4 5/16 3/8 7/16 1/2 9/16	
1910 KW	24teilig	410.—



**Ausbeulwerkzeuge
SPEZIALSTAHL**
moderne Formen

1911-
1916



Best.-Nr.	Bezeichnung	Preis
1911	Handfaust, Kommaform, Bahnlänge 140 mm, Breite 55 mm	22.20
1912	Handfaust, 80 x 70 mm und 100 x 45 mm, Höhe 58 mm	22.20
1913	Handfaust, Spezialform, 60 x 70 mm, Höhe 70 mm	22.20
1914	Handfaust, Beilform, 65 x 25 mm und 50 x 8 mm, Höhe 140 mm	14.20
1915	Handfaust, kräftige Aus- führung, 75 x 6 mm und 45 x 25 mm, Höhe 190 mm	26.60
1916	Handfaust, 70 x 60 mm, Höhe 50 mm	16.40



**Ausbeulwerkzeuge
SPEZIALSTAHL**

1917-
1924



Best.-Nr.	Bezeichnung	Preis
1917	Handfaust, 70 x 60 mm, Höhe 40 mm	16.40
1918	Handfaust, 110 x 65 mm, Höhe 25 mm	16.40
1919	Handfaust, Zehenform, 115 x 55 mm, Höhe 28 mm	16.40
1920	Universal-Handfaust, 70 x 50 mm u. 60 x 45 mm, Höhe 60 mm	24.30
1921	Handfaust, halbrund, 80 x 60 mm, Höhe 35 mm	15.10
1922	Handfaust, Diaboloform, 55 mm ø, Höhe 58 mm	15.30
1923	Handfaust, kräftige Ausf. 110 x 60 mm, Höhe 45 mm	24.80
1924	Handfaust, gebogen	45.50



**Ausbeulwerkzeuge
SPEZIALSTAHL**

1926-
1931

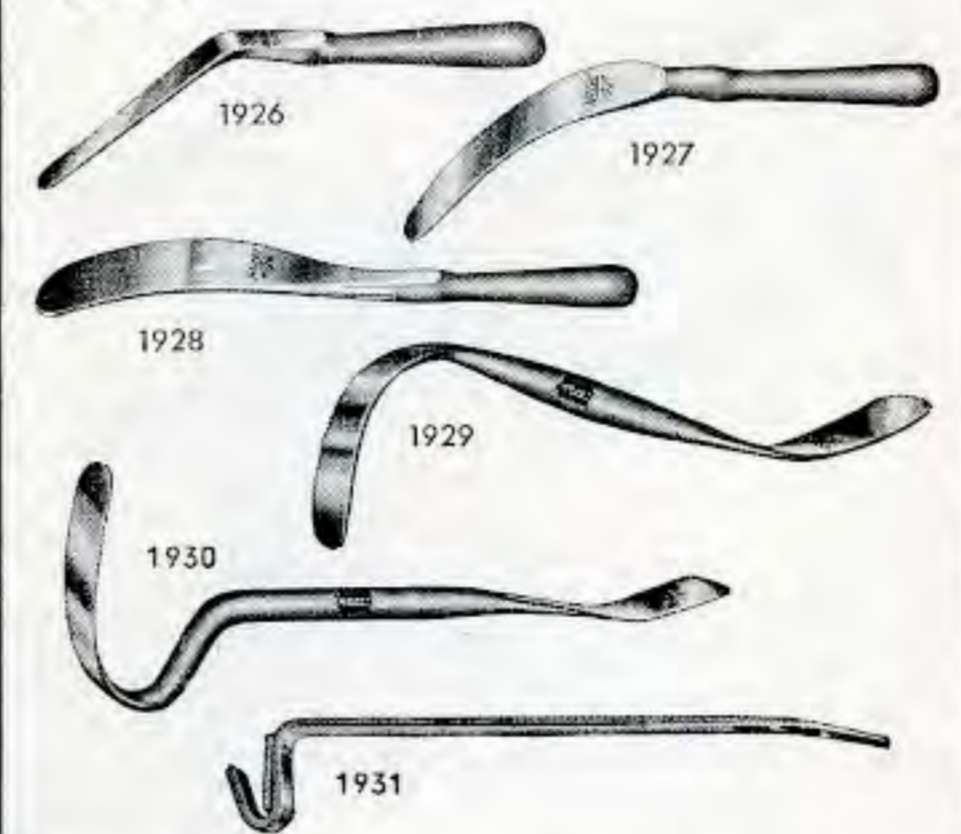

Best.-Nr.	Bezeichnung	Preis
1926	Löffeleisen, 30x20x130 mm Arbeitsfläche, 290 mm lang	12.70
1927	Löffeleisen, 52 x 150 mm Arbeitsfläche, 310 mm lang	16.20
1928	Löffeleisen, 60 x 30 x 200 mm Arbeitsfläche, 390 mm lang	21.10
1929	Ausbeul-Hebeleisen, 60 x 40 x 200 mm, gekröpft und geschweift, 425 mm lang	27.—
1930	Ausbeul-Hebeleisen, wie vor, jedoch stark gekröpft und doppelgeschweift, 525 mm lang	31.80
1931	Biegeeisen mit Lederein- satz, 420 mm lang	11.20



Ausbeulwerkzeuge SPEZIALSTAHL

1933-
1934

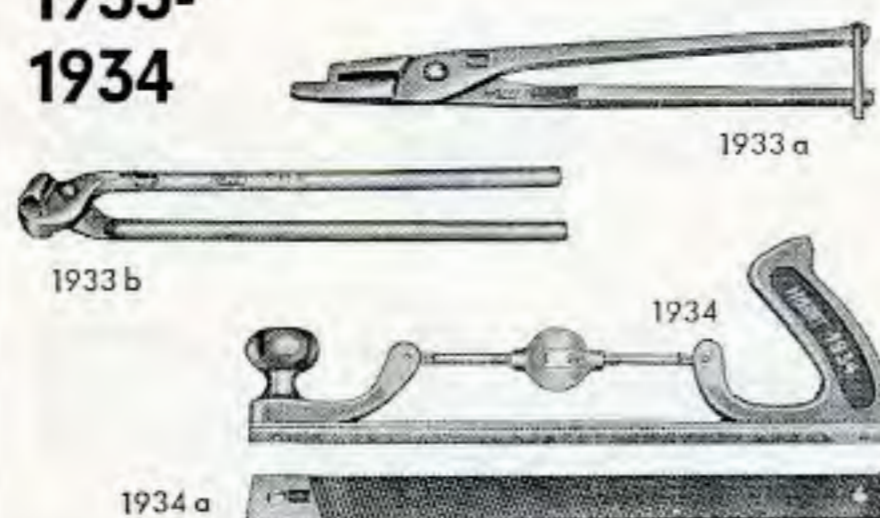

Bestell-Nr.	Bezeichnung	Preis
1933a	Kofflügel-Biegezange mit beweglichem Spannungring, 300 mm lang	10.—
1933b	Bördelzange, 300 mm lang	9.40
1934	Karosseriefeilenhalter, verstellbar, mit Feilenblatt	35.20
1934a	Feilenblatt, grob	12.—



Ausbeulwerkzeuge SPEZIALSTAHL

1935-
1941



Bestell-Nr.	Bezeichnung	Bahn mm	Preis
1935	Ausbeul- u. Schlichthammer, 150 mm	○ 33 ○ 44	14.20
1936	Spann- u. Ausschlichthammer, 165 mm	○ 32 □ 25	14.20
1937	Spann- und Schlichthammer, 100 mm	□ 25 ○ 32	12.—
1937 K	dto., jedoch die runde Bahn kariert gefräst	□ 25 ○ 32	16.20
1938	Spann- und Schlichthammer, 105 mm	□ 35 ○ 40	14.40
1938 K	dto., jedoch die runde Bahn kariert gefräst	□ 35 ○ 40	17.70
1939	Spann- und Schlichthammer, 110 mm	□ 41 ○ 46	16.20
1939 K	dto., jedoch die runde Bahn kariert gefräst	□ 41 ○ 46	19.40
1940	Schlicht- und Treibhammer, 160 mm	○ 41 ○ 20	14.20
1941	dto., jedoch eichel-förmige Bahn	○ 41 ○ 20	14.20



Ausbeulwerkzeuge SPEZIALSTAHL

1942-
1948



Bestell-Nr.	Bezeichnung	Bahn mm	Preis
1942	Schlicht- und Spitzhammer, 130 mm	○ 41	14.20
1943	Schlicht- und Pinnhammer, 160 mm	○ 41	16.—
1944	Schlicht- und Schweißhammer, 150 mm	□ 27/23 □ 38/20	16.—
1945	dto., jedoch gekreuzt	□ 27/23 □ 38/20	16.—
1946	Tiefhammer, 175 mm	○ 30	14.20
1948	Gummi- und Handhammer, kombiniert	○ 50 ○ 36	23.—



Plastic-Hämmer mit auswechselbaren Einsätzen

1950



Bestell-Nr.	mm	Pack-Norm	Preis
1950 - 1	22 ø	1	5.60
2	27 ø	1	6.60
3	32 ø	1	8.70
4	35 ø	1	10.60
5	40 ø	1	13.50
6	50 ø	1	19.30
7	60 ø	1	26.50



Lose Einsätze aus durchsichtigem Kunststoff

1950



Montage: Die losen Einsätze werden im Wasser vorgewärmt und durch einige Hammerschläge auf den Zapfen des Mittelstückes getrieben

Bestell-Nr.	mm	Pack-Norm	Preis per Paar
1950 - 22	22 ø	5	2.20
27	27 ø	5	3.10
32	32 ø	5	4.10
35	35 ø	5	5.80
40	40 ø	5	6.80
50	50 ø	5	12.—
60	60 ø	5	16.30



Klebschlag-Hammer

1959-3

DBP Nr. 1088 888 und Auslandspatente mit dauerplastischer Füllmasse für material-schonende Schläge



Bestell-Nr.	mm	Pack-Norm	Preis
1959 - 3	280	1	38.30



Karosserie-Blechsneider

1960

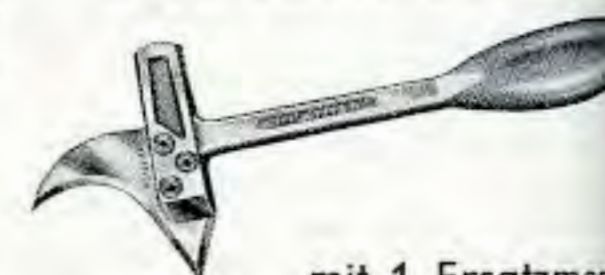

Bestell-Nr.	mm	Pack-Norm	Preis
1960	275	1	26.30

Lose Ersatzmesser

1960 - 1	1	8.20
----------	---	------



Außen-Ausbeulgerät

1965



Bestell-Nr.	mm	Pack-Norm	Preis
1965	440	1	21.60

Lose Anlötschlaufen und Bolzen

Bestell-Nr.	Bezeichnung	Pack-Norm	Preis per 10 Stk.
1965 - 1	Anlötschlaufen	10	6.40
1965 - 2	Bolzen	2	3.10



Magnetsucher

1976

400 g Haftfähigkeit mit Permanent-Magnet, Transparentheft

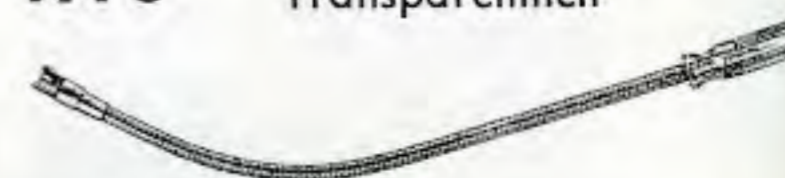

Bestell-Nr.	mm	Pack-Norm	Preis
1976	520	1	19.60

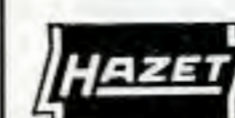

Metallsägebogen verstellbar

1980



1980	475	1	13.40
------	-----	---	-------

Lose Sägeblätter, einseit., 2% Wolfram legiert

1980 B - 1	225 x 16 x 0,8	6	-80
2	300 x 16 x 0,8	6	-90



Metallsägebogen feststehend

1981



1981	460	1	9.—
------	-----	---	-----

Lose Sägeblätter, einseit., 2% Wolfram legiert

1980 B - 2	300 x 16 x 0,8	6	-90
------------	----------------	---	-----



Verkaufs- und
Ausstellungsschränke
groß

2000

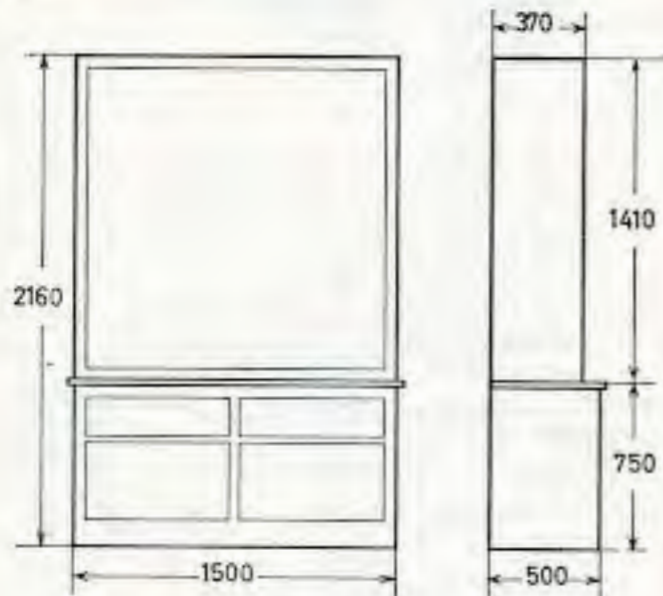
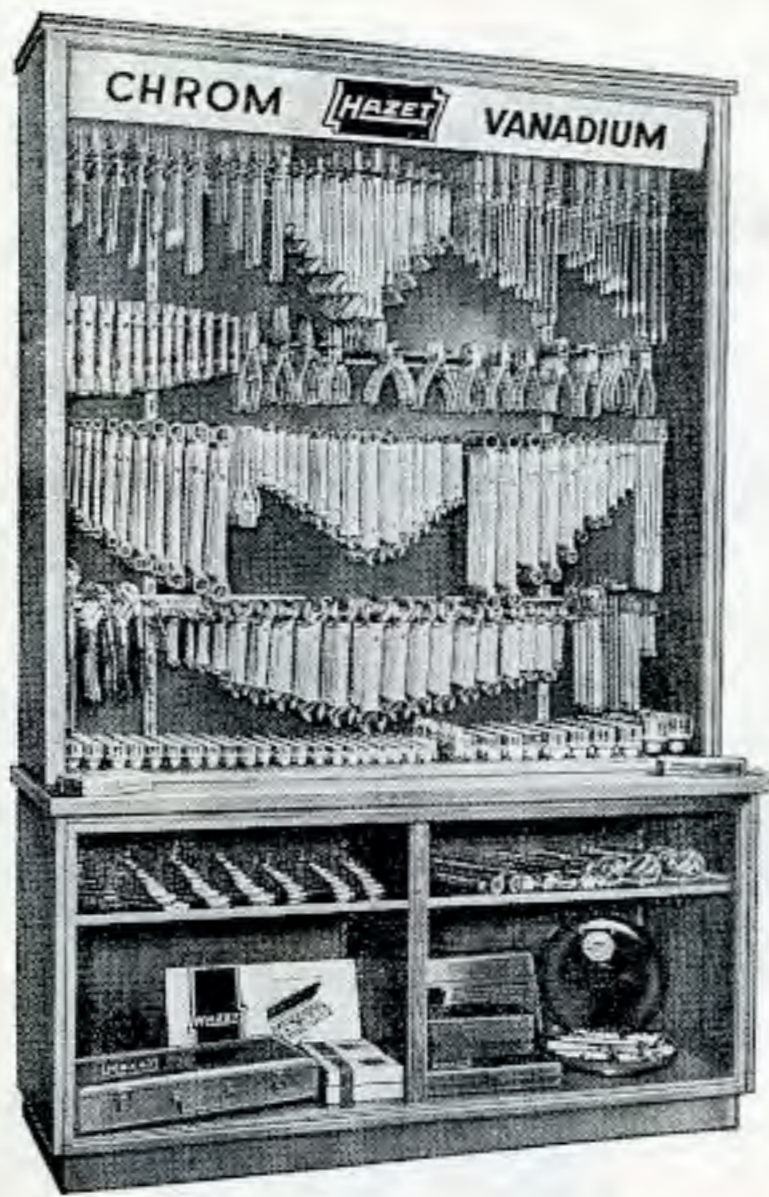

mit verschiedenen Werkzeug-Sortimenten
in metrischen, amerikanischen und eng-
lischen Maßen lieferbar

Preise auf Anfrage



Verkaufs- und
Ausstellungsschränke
klein

2010

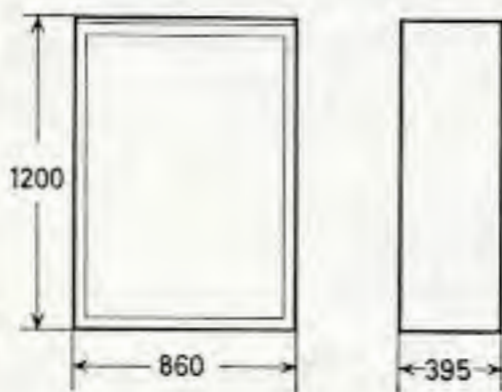
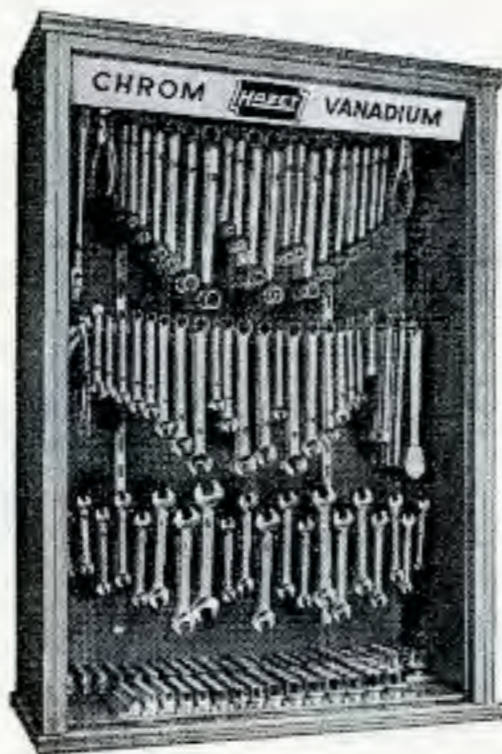

mit verschiedenen Werkzeug-Sortimenten
in metrischen, amerikanischen und eng-
lischen Maßen lieferbar

Preise auf Anfrage



Sechskant-
Stiftschlüssel
CHROM-VANADIUM

2100

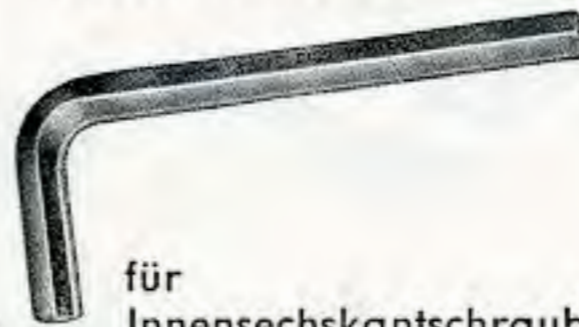

Metr. Maße für Innensechskantschrauben

Bestell-Nr. u. Größe	Länge mm	Pack-Norm	Glanzvernickelt
2100 - 2	60	5	- .80
3	68	5	- .84
4	76	5	- .92
5	85	5	1.02
6	96	5	1.28
7	100	5	1.50
8	108	5	1.66
9	115	5	1.90
10	122	5	2.02
12	137	5	2.56
14	154	5	3.50
17	177	5	5.94
19	194	5	7.92
22	222	5	10.56

Amerik. Maße

2100 A - 5/64	50	5	- .80
3/32	55	5	- .84
1/8	60	5	- .84
5/32	65	5	- .92
3/16	75	5	1.02
7/32	80	5	1.14
1/4	85	5	1.28
5/16	100	5	1.66
3/8	115	5	2.02
1/2	140	5	2.84
9/16	155	5	3.50
5/8	170	5	5.10
3/4	200	5	7.44

Sätze in Plastic-Taschen
Metr. Maße

Bestell-Nr.	Inhalt	Glanzvernickelt
2100 / 7 P	2 - 8	9.20
2100 / 10 P	2 - 12	19.30
2100 / 14 P	2 - 22	49.30

Amerik. Maße

2100 / 9 AP	5/64 - 3/8	14.60
2100 / 11 AP	5/64 - 9/16	22.—
2100 / 13 AP	5/64 - 3/4	35.40



Sechskant-
Stiftschlüssel
CHROM-VANADIUM
Transparentheft

2110



Metr. Maße für Innensechskantschrauben

Bestell-Nr. u. Größe	Länge mm	Pack-Norm	Glanzvernickelt
2110 - 2	90	2	1.40
3	95	2	1.70
4	120	2	1.80
5	125	2	2.10
6	135	2	2.60
7	150	2	3.10
8	155	2	3.20
9	165	2	3.50
10	170	2	3.60
12	195	2	5.—

Amerik. Maße

2110 A - 5/64	90	2	1.40
3/32	90	2	1.40
1/8	95	2	1.70
5/32	115	2	1.80
3/16	125	2	2.10
7/32	125	2	2.30
1/4	130	2	2.50
5/16	155	2	3.30
3/8	165	2	3.60
1/2	205	2	5.10



Vielzahnschlüssel
CHROM-VANADIUM

2111

für XZN-Schrauben
sehr genauer Paßsitz



gebogen
beide Enden gefräst

Bestell-Nr.	für Schrauben M	Länge mm	Pack-Norm	Glanzvernickelt
2111 - 05	5	72	5	1.80
06	6	80	5	2.—
08	8	90	5	2.60
10	10	100	5	4.—
12	12	112	5	4.90
14	14	125	5	7.30
16	16	140	5	8.60



Vielzahnschlüssel
CHROM-VANADIUM

2112

für XZN-Schrauben
sehr genauer Paßsitz
Transparentheft



gebogen
ein Ende gefräst

2112 - 05	5	110	2	2.40
06	6	130	2	2.90
08	8	150	2	3.80
10	10	160	2	5.30
12	12	190	2	6.50

Zuordnung der XZN-Schrauben für
Opel-Fahrzeuge

Schrauben M	Opel-Typ	Einbaustelle
6	Lkw	Drucklagerführung an Kupplungsgehäuse
8	Rekord, Kadett, Kapitän, Admiral, Lkw	Ölfilter an Zylinderblock
8	Rekord, Kapitän, Admiral, Lkw	Nockenwelle an Zylinderblock
8	Kadett, Rekord, Kapitän, Admiral, Lkw	Kraftstoffpumpe an Zylinderblock
8	Kadett	Sitzverstellung auf Unterbau Auspuffkrümmer an Zylinderblock Ölpumpe an Zylinderblock
8	Kapitän, Admiral	Ausrückhebel an Kupplungsgehäuse
8	Kapitän, Admiral, Diplomat	Sitzverstellung an Liegesitzrahmen
10	Kadett	Zylinderkopf an Zylinderblock
10	Rekord, Kapitän, Admiral	Dämpfungsbock an Zylinderblock
10	Rekord	Wasserpumpe an Zylinderblock
10	Kapitän, Admiral, Diplomat	Halter Bremsattel an Achsschenkel Bremscheibe an Nabe Vorderrad Motoraufrichtung an Halter, hinten Motor



Ergänzungswerkzeuge für Sortimente

2120-2125



Bestell-Nr.	Bezeichnung	Preis
2120 - 8	Rundfeile 8"	4.30
10	Rundfeile 10"	5.60
2122 - 5	Flachfeile 5"	3.10
8	Flachfeile 8"	4.20
10	Flachfeile 10"	5.70
2123 - 6	Dreikantfeile 6"	3.80
8	Dreikantfeile 8"	4.30
10	Dreikantfeile 10"	5.90
2125	Kontaktfeile	1.30
2125 P	Kontaktfeilen-Satz in Plastic-Tasche, 6 tlg.	8.50



Gewindefeilen

SPEZIALSTAHL
zum Nachfeilen beschädigter Außen- und Innengewinde

2126



Metr. Maße

Bestell-Nr.	Steigung mm	Metr. Gewinde	Länge mm	Preis
2126	0,80	5	230	17.50
	1,00	6 u. 7		
	1,25	8 u. 9		
	1,50	10 u. 11		
	1,75	12		
	2,00	14 u. 16		
	2,50	18, 20 u. 22		
	3,00	24 u. 27		

Amerik. Maße

Bestell-Nr.	Gänge auf 1"	SAE/USS Gewinde	Länge mm	Preis
2126 A	24	5/16 u. 3/8	230	17.50
	20	7/16 u. 1/2		
	18	9/16 u. 5/8		
	16	3/4		
	14	7/8 u. 1		
	13	—		
	12	1 1/8, 1 1/4, 1 3/8 u. 1 1/2		
	11	—		

Engl. Maße

Bestell-Nr.	Gänge auf 1"	Whitworth-Gewinde	Länge mm	Preis
2126 W	26	3/16	230	17.50
	24	3/16 u. 7/32		
	20	1/4		
	18	5/16		
	16	3/8		
	14	7/16		
	12	1/2 u. 9/16		
	11	5/8 u. 11/16		



Ergänzungswerkzeuge für Sortimente

2130-2161

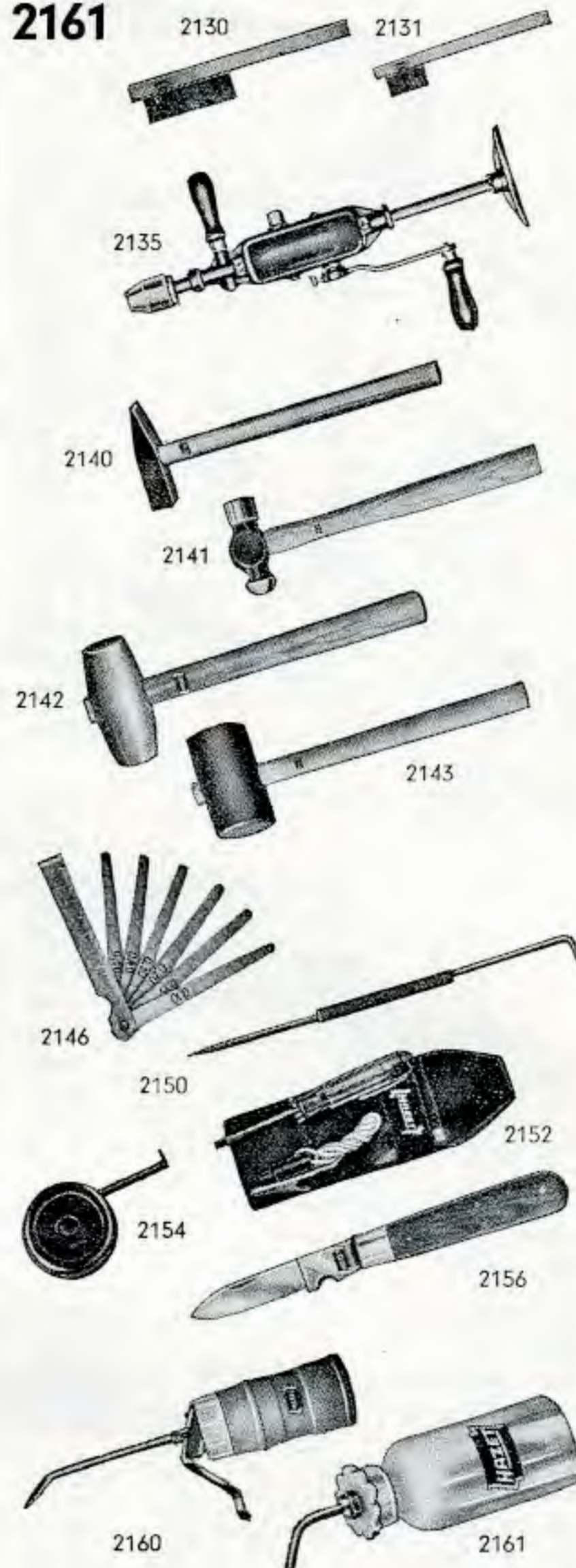

Bestell-Nr.	Bezeichnung	Preis
2130	Drahtbürste	1.50
2131	Zündkerzenbürste	1.10
2135	Handbohrmaschine	54.40
2140 - 2	Schlosserhammer 200 g	4.30
3	dto. 300 g	5.—
4	dto. 400 g	5.30
5	dto. 500 g	6.20
10	dto. 1000 g	9.80
2141 - 1	Engl. Hammer 3/4 lbs.	6.30
2	dto. 1 lbs.	6.80
4	dto. 2 lbs.	10.80
2142	Leichtmetallhammer 500 g	11.90
2143	Gummihammer 90 x 50 mm 500 g	6.40
2146	Fühlerblattlehre 6 teilig für VW	2.80
2147	dto., 20teilig „Spion“	8.10
2147 A	dto., SAE-Maße	9.10
2150	Reißnadel	3.60
2152	Prüflampe (Schraubendreher mit Prüflampe u. Anschlusskabel) im Etui	5.20
2154	Rollbandmaß, 2 m	2.20
2156	Kabelmesser	5.40
2160	Ölspritzkanne	8.70
2161	Kännchen für Öl oder Caramba, „Ölboy“	4.40



Hebeleisen

2165

CHROM-VANADIUM
zum Abheben des Zylinderkopfes, Lösen festgerosteter Teile, Ein- und Austreiben von Lagern und Lagerschalen, Ein- und Ausbau der Federn, Bolzen, Zahnräder usw.

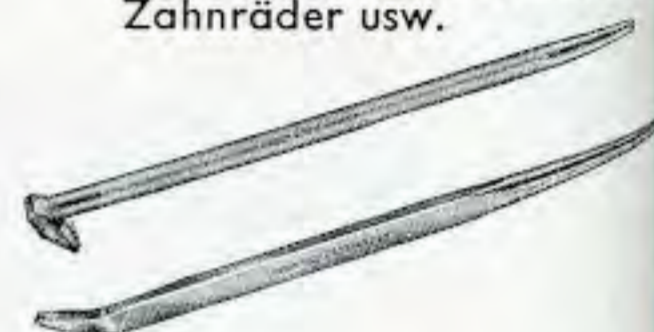

Bestell-Nr.	Länge mm	Zoll	Pack-Norm	Glasvernickt
2165 - 1	400	16	5	11.30
2165 - 2	400	16	5	10.40



Klein-Rohrabschneider

2180

für Rohre aus Kupfer, Messing und sonstigen NE-Metallen



Mit einem Rädchen für alle Rohrarten, mit doppelter Rollenführung Selbsttätiger Vorschub während des Schneidens, ohne Nachstellen der Spindel

Bestell-Nr.	Bezeichnung	Pack-Norm	Preis
2180	für Rohre bis 29 mm = 1 1/8" Außen-Ø	1	29.50
2180 - 1	Ersatzrädchen 20 x 4,8 x 5,1 mm	1	4.80
2180 - 2	Ersatzbolzen für Rädchen	1	—,50



Bördelgerät

2190

für Bremsleitungen usw., mit auswechselbaren, scharnierten Spannbacken

Verbessertes Modell

mit selbsttätiger Oberflächen-glättung beim Lösen der Druckspindel

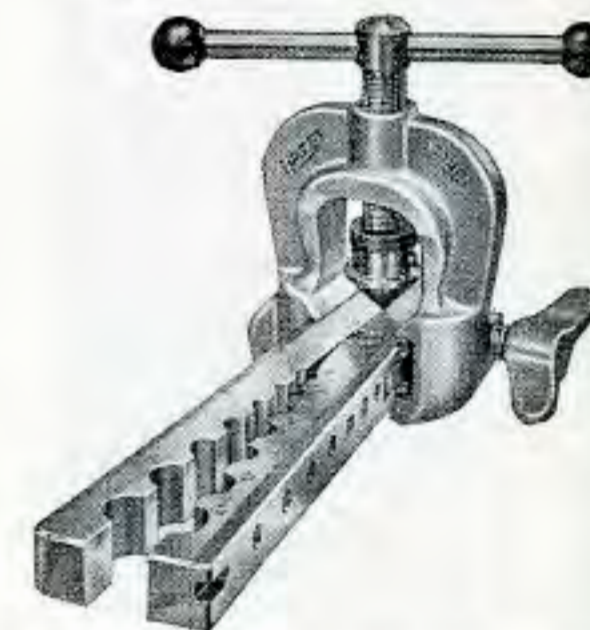

Bördelmöglichkeit von 90-180° in einer Einspannung

Bestell-Nr.	mit Spannbacken	Pack-Norm	Preis
2190	mm	1	49.50
2190 A	Zoll	1	49.50
Ersatz-Spannbacken			
2190 - 1	4 4,75 6 8 10 12 14 mm	1	29.70
2190 - 2	3/16 1/4 5/16 3/8 7/16 1/2 5/8" A	1	29.70
Ersatz-Druckstück			
2190 - 5	für 180° Bördelung	1	1.50



Schraubendreher-Einsätze
und Kombinationsstücke
CHROM-VANADIUM

2200

für Elektro- und Preßluftschrauber

für allerhöchste Beanspruchung
Größte Maßgenauigkeit der Spitzen und Schneiden



Schraubendreher-Einsätze (Bits)
für Innensechskantschrauben



1/4" Sechskant-Antrieb

Bestell-Nr.	Innensechskant-Schlüsselweite mm	Für Schrauben DIN 912	Länge mm	Pack-Norm	Preis
2203 - 1	3	M 4	25	10	2.80
2	4	M 5	34	10	2.80
3	5	M 6	34	10	2.80
4	6	M 8	34	10	2.80
5	8	M 10	34	10	3.30
6	10	M 12	34	10	3.30

5/16" Sechskant-Antrieb

Bestell-Nr.	Innensechskant-Schlüsselweite mm	Für Schrauben DIN 912	Länge mm	Pack-Norm	Preis
2205 - 1	3	M 4	25	10	3.10
2	4	M 5	34	10	3.10
3	5	M 6	34	10	3.10
4	6	M 8	34	10	3.10
5	8	M 10	34	10	3.70
6	10	M 12	34	10	3.70



Schraubendreher-Einsätze (Bits)
für Schlitzschrauben



1/4" Sechskant-Antrieb

Bestell-Nr.	Klingenbreite mm	Klingenstärke mm	Länge mm	Pack-Norm	Preis
2209 - 1	4	0,55	38	10	2.20
2	5	0,75	38	10	2.20
3	6	0,90	38	10	2.20
4	7	0,90	38	10	3.10
5	8	1,10	38	10	3.10
6	8	1,50	38	10	3.10
7	10	1,15	38	10	3.10
8	10	1,50	38	10	3.10

5/16" Sechskant-Antrieb

Bestell-Nr.	Klingenbreite mm	Klingenstärke mm	Länge mm	Pack-Norm	Preis
2211 - 1	5	0,75	38	10	2.50
2	6	0,90	38	10	2.50
3	7	0,90	38	10	2.50
4	8	1,10	38	10	2.50
5	8	1,50	38	10	2.50
6	10	1,15	38	10	3.50
7	10	1,50	38	10	3.50
8	12	1,15	38	10	4.20
9	12	1,90	38	10	4.20
10	14	1,95	38	10	4.90
11	14	2,40	38	10	4.90



Schraubendreher-Einsätze (Bits)
für Kreuzschlitzschrauben



Spitzen PHILLIPS-RECESS nach DIN 5261 1/4" Sechskant-Antrieb

Bestell-Nr.	Größe Nr.	Länge mm	Pack-Norm	Preis
2215 - 1	1	25	10	2.—
2	2	25	10	2.—
3	2	50	10	2.10
4	3	32	10	3.10
5	4	32	10	3.50



Schraubendreher-Einsätze
und Kombinationsstücke
CHROM-VANADIUM

2200



Schraubendreher-Einsätze (Bits)
für Kreuzschlitzschrauben



Spitzen PHILLIPS-RECESS nach DIN 5261 5/16" Sechskant-Antrieb

Bestell-Nr.	Größe Nr.	Länge mm	Pack-Norm	Preis
2217 - 1	1	32	10	2.50
2	2	32	10	2.50
3	3	32	10	2.50
4	4	38	10	3.10

Verbindungsstücke

für Schraubendreher-Einsätze,
einerseits Vierkant-Antrieb,
andererseits Sechskant-Aufnahme
für Schraubendreher-Einsätze HAZET 2203-2217



Bestell-Nr.	Vierkant Zoll	Sechskant Zoll	Länge mm	Pack-Norm	Preis
2230 - 1	1/4	1/4	25	10	6.30
2	3/8	1/4	30	10	7.30
3	3/8	5/16	30	10	8.60
4	1/2	1/4	35	10	8.60
5	1/2	5/16	35	10	9.90

Kombinationsstücke

zur Aufnahme von Schraubendreher-Einsätzen zum Einsetzen in Elektro- und Preßluftschrauber mit äußerst präziser Paßform, zur weitgehenden Schonung von Schraube, Gerät und Werkstück. Durch Verwendung von Kombinationsstücken rationelle Ausnutzung des Verschleißteiles. Leichtes Auswechseln der Einsätze bei weiterer Verwendung des Kombinationsstückes ergeben Senkung der Betriebskosten.

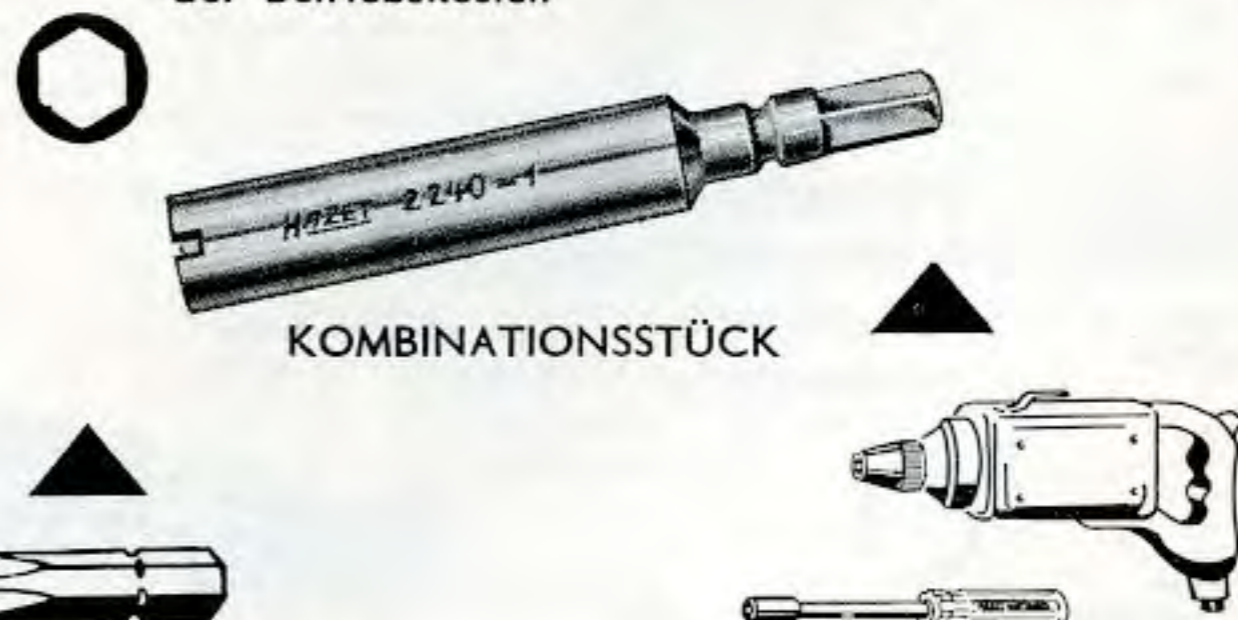

KOMBINATIONSTÜCK

Schraubendreher-Einsatz

Elektro-/Preßluft-Schrauber oder Halter (Handbetrieb)

für Schraubendreher-Einsätze mit 1/4" Sechskant-Antrieb

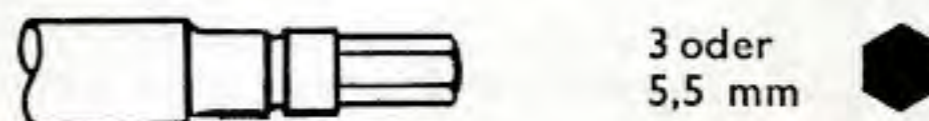

3 oder 5,5 mm

Bestell-Nr.	Länge mm	Antrieb	für Elektro- und Preßluftschrauber	Pack-Norm	Preis
2240 - 1	57	3 mm	BOSCH-Elektroschrauber	5	9.70
2	70	5,5 mm	BOSCH-Elektroschrauber, Metabo u. a.	5	9.70

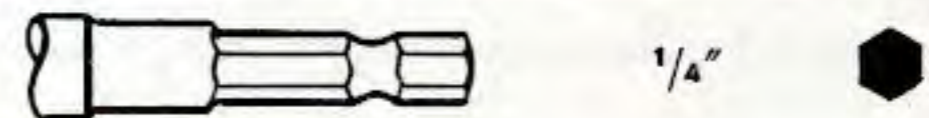

1/4"

Bestell-Nr.	Länge mm	Antrieb	für Elektro- und Preßluftschrauber	Pack-Norm	Preis
2242 - 1	57	1/4"	Elektro- u. Preßluftschrauber BLACK & DECKER, STANLEY, THOR, VAN DORN usw.	5	9.70



Schraubendreher-Einsätze und Kombinationsstücke

CHROM-VANADIUM

2200

Kombinationsstücke

für Schraubendreher-Einsätze mit 1/4" Sechskant-Antrieb

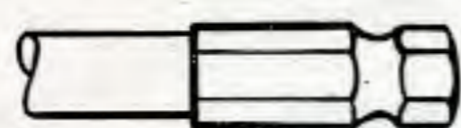

11 oder
17 mm



Bestell-Nr.	Länge mm	Antrieb	für Elektro- und Preßluftschrauber	Pack-Norm	Preis
2244 - 1	70	11 mm	Elektro- u. Preßluftschrauber AEG, BOSCH, FEIN, BLACK & DECKER, STANLEY usw.	5	11.20
2	70	17 mm	FEIN	5	14.20

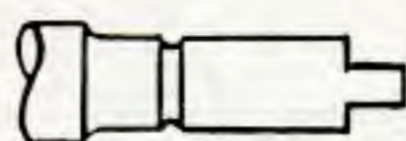

5 oder
7 mm



2246 - 1	57	5 mm	FEIN-Elektroschrauber	5	9.70
2	70	7 mm	FEIN-Elektroschrauber	5	9.70

für Schraubendreher-Einsätze mit 5/16" Sechskant-Antrieb

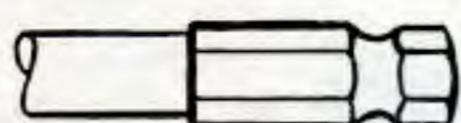

11 oder
17 mm



2250 - 1	70	11 mm	Elektro- u. Preßluftschrauber AEG, BOSCH, FEIN, BLACK & DECKER, STANLEY usw.	5	11.20
2	70	17 mm	FEIN	5	16.90



Schraubendreher-Einsatz-Halter

CHROM-VANADIUM

2255

2256

für Handbetrieb, Transparentheft

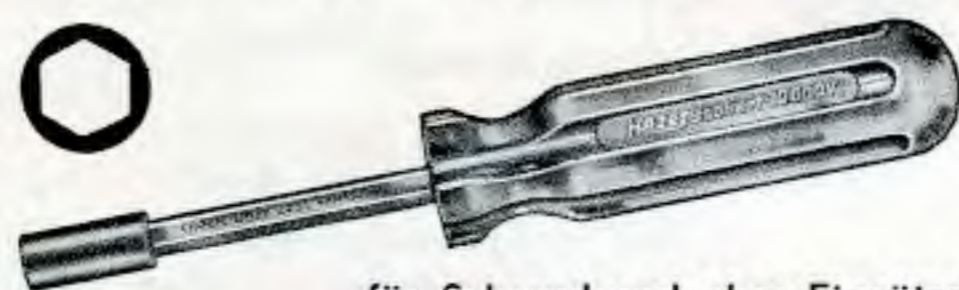

für Schraubendreher-Einsätze
mit 1/4" oder 5/16" Sechskant-Antrieb

Bestell-Nr.	für Einsätze mit Sechskant-Antrieb	Klingenlänge mm	Total-Länge mm	Pack-Norm	Preis
2255	1/4"	75	180	5	8.40
2256	5/16"	100	200	5	9.50



Schraubendreher-Einsatz-Halter

CHROM-VANADIUM

2257

für Handbetrieb, Transparentheft mit Magazin



Der neue HAZET-Schraubendreher-Einsatz-Halter mit Magazin hat am Kopf des schlagfesten Transparentheftes einen Schraubverschluss

Im Heft können 4 oder 7 gangbare Schraubendreher-Einsätze untergebracht werden, so daß jederzeit der passende Einsatz greifbar ist

Der Halter mit magnetischer Klingenaufnahme wird für Schraubendreher-Einsätze mit 1/4" Sechskant-Antrieb geliefert

Der im Halter eingebaute **DAUERMAGNET** hält sowohl die Einsteck Klinge (Bit) als auch die zu betätigende Schraube

für Schraubendreher-Einsätze mit 1/4" Sechskant-Antrieb

Bestell-Nr.	für Einsätze mit Sechskant-Antrieb	Klingenlänge mm	Total-Länge mm	Pack-Norm	Preis
2257	1/4"	130	240	5	15.90



Schraubendreher-Einsätze und Halter

CHROM-VANADIUM

2257

für Handbetrieb
mit Magazin

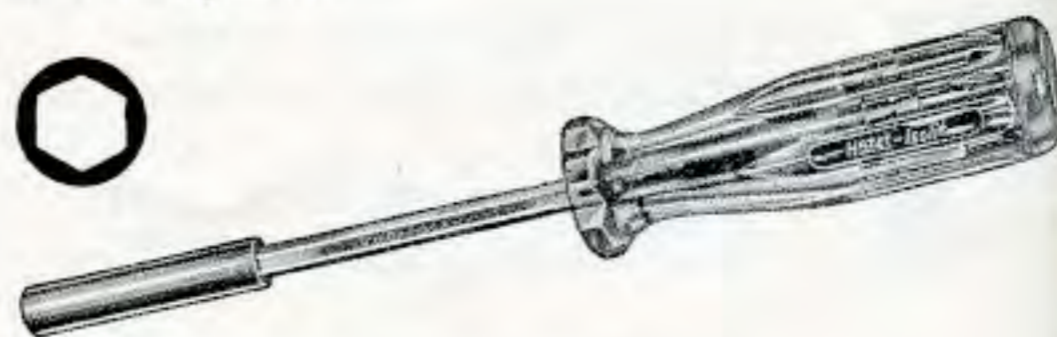

Sätze im Magazinhalter

1/4" Sechskant-Antrieb

Bestell-Nr.	Inhalt	Preis
	Halter 2257 Schraubendreher-Einsätze für Schlitzschrauben 2209-1 Klingbreite 4 mm 2209-3 Klingbreite 6 mm 2209-5 Klingbreite 8 mm Schraubendreher-Einsatz für Kreuzschlitzschrauben 2215-2 Größe Nr. 2	
2257/4		25.40
	Halter 2257 Schraubendreher-Einsätze für Schlitzschrauben 2209-1 Klingbreite 4 mm 2209-2 Klingbreite 5 mm 2209-3 Klingbreite 6 mm 2209-5 Klingbreite 8 mm Schraubendreher-Einsätze für Kreuzschlitzschrauben 2215-1 Größe Nr. 1 2215-2 Größe Nr. 2 2215-4 Größe Nr. 3	
2257/7		32.70



Schraubendreher-Einsätze und Halter

CHROM-VANADIUM

2260

für Handbetrieb

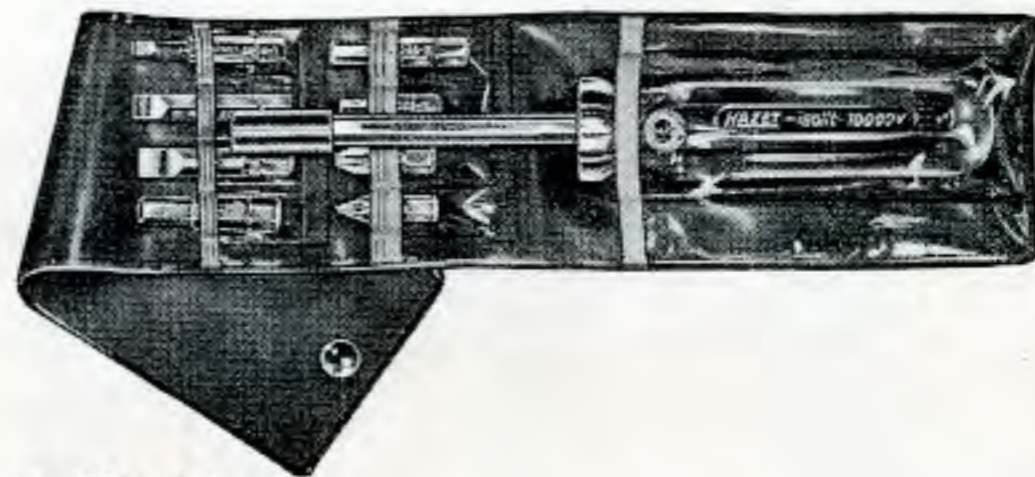

Satz in Plastic-Tasche
für Halter HAZET 2255

1/4" Sechskant-Antrieb

Bestell-Nr.	Inhalt	Preis
	Halter 2255 Schraubendreher-Einsätze für Innensechskantschrauben 2203-2 Schlüsselweite 4 mm 2203-4 Schlüsselweite 6 mm 2203-5 Schlüsselweite 8 mm Schraubendreher-Einsätze für Schlitzschrauben 2209-1 Klingbreite 4 mm 2209-3 Klingbreite 6 mm 2209-5 Klingbreite 8 mm Schraubendreher-Einsätze für Kreuzschlitzschrauben 2215-1 Größe Nr. 1 2215-2 Größe Nr. 2	
2260	9 teilig	30.80



Schlagschraubendreher SPEZIALSTAHL

2300

mit Einsätzen für Schlitz-, Kreuzschlitz- und Innensechskant-Schrauben sowie mit Verbindungsstücken



Drehmoment **10 mkg**

Schlagschraubendreher mit den entsprechenden Einsätzen werden überall da gebraucht, wo hohe Drehmomente nötig sind, um sehr fest sitzende Schrauben zu lösen. Wo ein normaler Schraubendreher diese nicht lösen kann, hilft der Schlagschraubendreher auf einfache Weise

Lösen der Schraube: Einsatz in den Schlagschraubendreher stecken und im Schraubenkopf ansetzen, Schlagschraubendreher-Griff bis zum Anschlag nach **links** drehen. Dann mit einem 300g-Hammer auf die Kopfseite des Schlagschraubendrehers schlagen

Anziehen der Schraube: Wie vor, jedoch Schlag-schraubendreher-Griff nach **rechts** drehen

Es genügen **leichte** Hammerschläge

Schlagschraubendreher

Drehmoment **10 mkg**

Bestell-Nr.	Länge		Pack-Norm	Preis
	mm	Zoll		
2300	130	5	5	94.60



Verbindungsstücke für normale Steckschlüsseleinsätze

Bestell-Nr.	für Steckschlüsseleinsätze mit Vierkant-Antrieb	Länge mm	Pack-Norm	Preis
2305	3/8"	37	10	13.—
2310	1/2"	37	10	13.—



Einsätze für Schlitzschrauben

Bestell-Nr.	Klingen-Breite / Stärke mm	für Schrauben M	Pack-Norm	Preis
2320-1	7 x 1	4	10	9.80
3	9 x 1,2	SMS (schwed. Standard)	10	9.80
5	9 x 1,4	5	10	9.80
7	10 x 1,6	6	10	9.80
9	12 x 2	8	10	9.80
11	13 x 1,5	SMS und Bosch-Aggregate	10	9.80
13	16 x 2,5	für Bosch-Aggregate	10	9.80



Einsätze für Kreuzschlitzschrauben Spitzen PHILLIPS-RECESS nach DIN 5261

Bestell-Nr.	Größe	für Schrauben M	Pack-Norm	Preis
2325-2	2	3,5-5	10	10.90
3	3	6	10	10.90
4	4	8-10	10	10.90



Schlagschraubendreher SPEZIALSTAHL

2300



Einsätze für Innensechskantschrauben

Bestell-Nr.	Schlüsselweite mm	für Schrauben nach DIN 912 M	Pack-Norm	Preis
2330-5	5	6	10	9.80
6	6	8	10	9.80
8	8	10	10	9.80
10	10	12	10	9.80



Satz im hausfarbenen HAZET-Metallkasten

Bestell-Nr.	Inhalt	Preis
	Schlagschraubendreher 2300 Drehmoment 10 mkg	
	Verbindungsstücke für normale Steckschlüsseleinsätze	
	2305 3/8" Vierkant-Antrieb	
	2310 1/2" Vierkant-Antrieb	
	Einsätze für Schlitzschrauben	
	2320-1 Klingbreite 7 mm	
	2320-5 Klingbreite 9 mm	
	2320-7 Klingbreite 10 mm	
	2320-9 Klingbreite 12 mm	
	2320-11 Klingbreite 13 mm	
	Einsätze für Kreuzschlitzschrauben	
	2325-2 Größe Nr. 2	
	2325-3 Größe Nr. 3	
	2325-4 Größe Nr. 4	
	Einsätze für Innensechskantschrauben	
	2330-5 Schlüsselweite 5 mm	
	2330-6 Schlüsselweite 6 mm	
	2330-8 Schlüsselweite 8 mm	
	2330-10 Schlüsselweite 10 mm	
2350	15 teilig	258.—

Wichtig:

Unbedingt genau zur Schraube passenden Einsatz verwenden

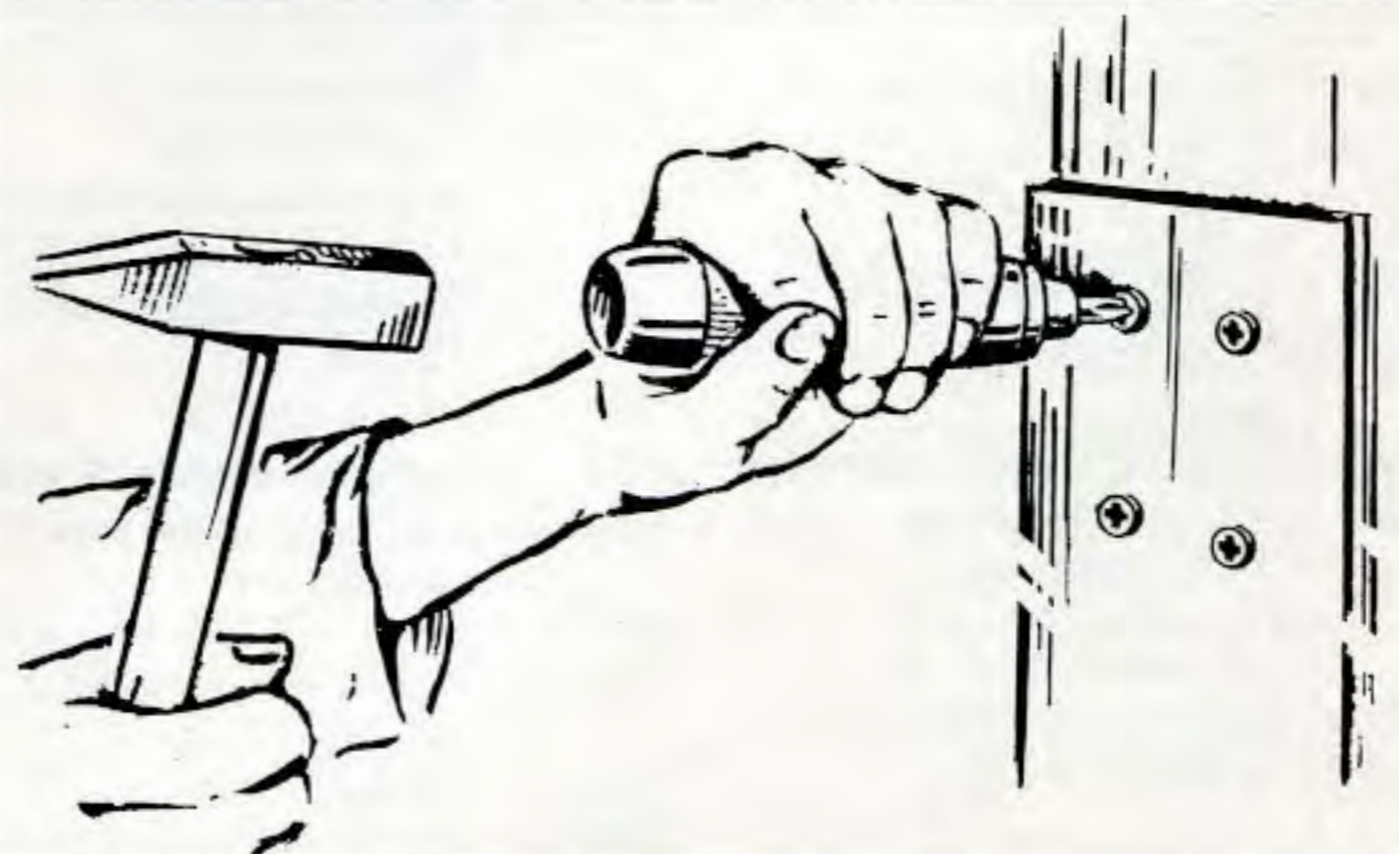



2500 A

Assistent

Werkzeug-, Material- und Montagewagen



für den innerbetrieblichen rationellen Transport

DBP Nr. 949640

und Auslandspatente

mit Werkzeugsortimenten **CHROM-VANADIUM**

für Volkswagen

Maße: 930 x 650 x 330 mm

Bestell-Nr.	Sortimente einschl. Werkzeugwagen	Gewicht kg	Verchromt
2500 A 1/71	71 teilig, 1 Zwischenkasten	36	688.—
2500 A 2/71	71 teilig, 2 Zwischenkästen	40	740.—
2500 A 1/68	68 teilig, 1 Zwischenkasten	39	1040.—
2500 A 2/68	68 teilig, 2 Zwischenkästen	43	1092.—
2500 A 1 L	Werkzeugwagen, leer mit 1 Zwischenkasten	22	284.—
2500 A 2 L	Werkzeugwagen, leer mit 2 Zwischenkästen	26	336.—

INHALTSÜBERSICHT HAZET 2500 A 1/71 bzw. 2500 A 2/71

450	Gabelschlüssel 6 x 7 8 x 10 10 x 14 12 x 14 22 x 27	922	Innensechskant-Einsatz 10 mm
450	dito, je 2 Stück 9 x 11 14 x 17 17 x 19	1801-2 1850-3	Seitenschneider 6 1/2" Kombizange 7"
605	Gabel-Ringschlüssel, kurz, 13 x 13 15 x 15	2100	Sechskant- Stiftschlüssel 8 mm
615	Starter- und Block- schlüssel 11 x 13	2120-8	Rundfeile 8"
630	Ringschlüssel, gekröpft, 6 x 7 8 x 10 12 x 14 17 x 19	2122-8	Flachfeile 8"
650-12	Reifenheber 12", 2 Stück	2125	Kontaktfeile
731-5	Flachmeißel 150 x 15	2130	Drahtbürste
745-10	Durchschläger 120 x 2	2140-3	Hammer 300 g
746-2	Körner 120 x 12	2140-5	dito 500 g
760-3	Universalzange 9 1/2"	2143	Gummihammer 90 x 50
811-3	Werkstattschraubend- dreher 100 x 6	2146	Fühlerlehre, 6tlg.
811-9	dito 150 x 8	2150	Reißnadel
813-2	Elektrikerschraubend- dreher 80 x 3	2152	Prüflampe
814-2	Kreuzschlitzschraubend- dreher für Phillips- Schrauben Nr. 5-10	2161	Ölkännchen, 2 Stück
821-1	Dreikantschaber 150	2505	Spezial-Zündkerzen- schlüssel
834-3	Schraubendreher für Vergaser, 25 x 8	2509	Spezial-Ringschlüssel 10 x 14
900	Sechskanteinsätze 1/2" □ Antrieb 10 11 13 14 15 17	2513-24a	Gabelschlüssel, einseitig gerade, 24 mm
915	T-Griff 12"	b	gebogen, 24 mm
916	Umschaltknarre 12"	2513-27	a und b, 27 mm
917	Verlängerung 5"	2513-32	a und b, 32 mm
918	Verlängerung 10"	2527-13	Steckschlüssel 13 mm
921	Innensechskant-Einsatz 8 mm	2527-14	dito 14 mm
		2559-24	Öldruckschalter- schlüssel 24 mm
		2561	Ringschlüssel 21 x 36
		2565	Spezienschlüssel für Zylinderkopfmutter 15 mm
		2567	Spezienschlüssel für den Öldienst

INHALTSÜBERSICHT HAZET 2500 A 1/68 bzw. 2500 A 2/68

605	Gabel-Ringschlüssel, kurz, 13 x 13 15 x 15	918	Verlängerung 10"
615	Starter- und Block- schlüssel 11 x 13	919	T-Griff-Schlüssel
630	Ringschlüssel, gekröpft, 17 x 19	921	Innensechskant-Einsatz 8 mm
790-1	Kolbenringzange 50-100	922	Innensechskant-Einsatz 10 mm
798	Schlauchklammernzange	1015	Schiebegriff 20"
900	Sechskanteinsätze 1/2" □ Antrieb 10 11 13 14 15 17 19 30	1056	Sechskanteinsatz 36 mm
911	Schwunggriff 16 1/2"	2505	Spezial-Zündkerzen- schlüssel
915	T-Griff 12"	2507	Dorn
917	Verlängerung 5"	2509	Spezial-Ringschlüssel 10 x 14
		2511	Führungsplatte
		2512	Hebelverlängerung

INHALTSÜBERSICHT (Forts.)

HAZET 2500 A 1/68 bzw. A 2/68

2513-24a	Gabelschlüssel, einseitig gerade, 24 mm	2533	Dorn für Bundbolzen- buchsen 17,9 mm ø
b	gebogen, 24 mm	2533a	dito 19,9 mm ø
2513-27	a und b, 27 mm	2559-24	Öldruckschalter- Schlüssel 24 mm
2513-32	a und b, 32 mm	2559-27	dito 27 mm
2514	T-Griff-Schlüssel, 150 mm lang	2560	Spezial-Ringschlüssel 27 x 36
2514-1	dito, 300 mm lang	2565	Spezienschlüssel für Zylinderkopfmutter 15 mm
2519	Führungsdorn	2566	Spezienschlüssel für Schalter des Scheiben- wischer-Motors
2520-10	Ventil-Einstell-Lehre 0,10 mm	2567	Spezienschlüssel für den Öldienst
2520-20	dito 0,20 mm	2568	Spezienschlüssel für Ventileinstellung
2523-75	Kolbenring- Spannband 75 mm	2569	Spezienschlüssel für Rollenlenkung
2523-77	dito 77 mm	2570	Ventileinschleifer
2523-83	dito 83 mm	2572	Spezienschlüssel für Brennstoffhahn
2524	Kerbstemmer	2573	Spezienschlüssel für Ansaugrohr
2525 K	Sprengringzange	2575/3	Kreuzschlitzschraubend- dreher (814-2, -3, -4)
2527-13	Steckschlüssel 13 mm	2576	Sprengringzange
2527-14	dito 14 mm	2590	Drehmomentschlüssel
2530a	Dorn für Achsschenkel- bolzen 7,9 mm ø		
2530b	dito 5,9 mm ø		
2531	Dorn für Achsschenkel- bolzenbuchsen 17,5 mm ø		
2531a	dito 21,5 mm ø		



"Tourist"

Werkzeugsätze für Volkswagen

CHROM-VANADIUM

2500 E

im Ersatzrad unterzubringen
DBP und Auslandspatente



2500 E für VW 1200

2500 E-2 für VW 1500 Limousine,
VW-Variant und Ghia

Bestell-Nr.	Sortimente einschl. Behälter	Gewicht kg	Verchromt
2500 E	12teilig im Metallbehälter	3,5	82.50
2500 E-2	14teilig im Kunststoffbehälter	3,0	127.60

INHALTSÜBERSICHT

HAZET 2500 E

450	Gabelschlüssel 7 x 8	811-9	Schraubendreher 150 x 8
450	dito 10 x 12	813-2	dito 80 x 3
605	Gabel-Ringschlüssel, kurz, 13 x 13	814-02	Kreuzschlitzschraubend- dreher für Phillips- Schrauben Nr. 5-10
605	dito 14 x 14	1850-2	Kombizange 6 1/2"
760-3	Universalzange 9 1/2"	2561	Ringschlüssel 21 x 36
764	Zündkerzenschlüssel		
772	Radschraubenkurbel		

INHALTSÜBERSICHT

HAZET 2500 E-2

450	Gabelschlüssel 7 x 8	814-3	Kreuzschlitzschraubend- dreher für Phillips- Schrauben Nr. 12-16
450	dito 9 x 11	814-02	Kreuzschlitzschraubend- dreher für Phillips- Schrauben Nr. 5-10
450	dito 10 x 14	1850-22	Kombizange 6 1/2"
600	Gabel-Ringschlüssel, lang, 13 x 13	2125	Kontaktfeile
760-3	Universalzange 9 1/2"	2505	Spezial-Zündkerzen- schlüssel
772	Radschraubenkurbel	2567	Spezienschlüssel für den Öldienst
811-6	Schraubendreher 125 x 7		
813-2	dito 80 x 3		



**Werkzeugsatz
CHROM-VANADIUM**

2500 T für Volkswagen

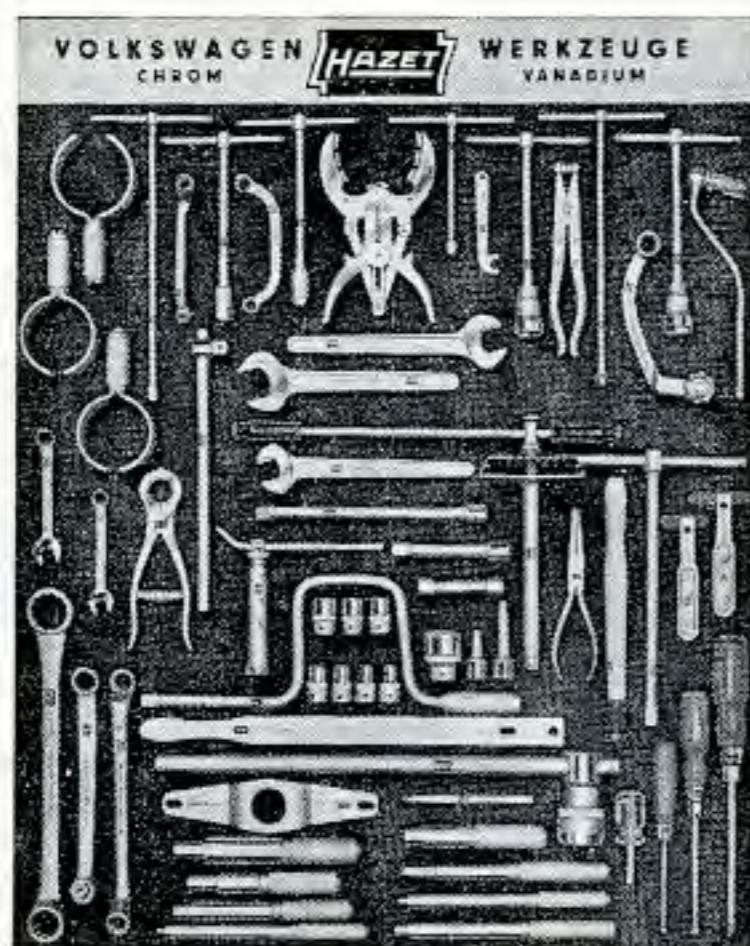

auf hausfarbener HAZET-Metallwandtafel

Tafelgröße: 1000 x 800 mm

Bestell-Nr.	Inhalt	Gewicht kg	Verchromt
605	Gabel-Ringschlüssel, kurz, 13 x 13 15 x 15	2524	Kerbstemmer
615	Starter- und Blockschlüssel 11 x 13	2525K	Sprengringzange
630	Ringschlüssel, gekröpft, 17 x 19	2527-13	Steckschlüssel 13 mm
790-1	Kolbenringzange 50-100	2527-14	dito 14 mm
798	Schlauchklemmenzange	2530a	Dorn für Achsschenkelbolzen 7,9 mm ø
900	Sechskanteinsätze 1/2" □ Antrieb 10 11 13 14 15 17 19 30	2530b	dito 5,9 mm ø
911	Schwunggriff 16 1/2"	2531	Dorn für Achsschenkelbolzenbuchsen 17,5 mm ø
915	T-Griff 12"	2531a	dito 21,5 mm ø
917	Verlängerung 5"	2533	Dorn für Bundbolzenbuchsen 17,9 mm ø
918	Verlängerung 10"	2533 a	dito 19,9 mm ø
919	T-Griff-Schlüssel	2559-24	Öldruckschalterschlüssel 24 mm
921	Innensechskant-Einsatz 8 mm	2559-27	dito 27 mm
922	dito 10 mm	2560	Spezial-Ringschlüssel 27 x 36
1015	Schiebegriff 20"	2565	Spezienschlüssel für Zylinderkopfmutter 15 mm
1056	Sechskanteinsatz 36 mm	2566	Spezienschlüssel für Schalter des Scheibenwischer-Motors
2505	Spezial-Zündkerzenschlüssel	2567	Spezienschlüssel für den Öldienst
2507	Dorn	2568	Spezienschlüssel für Ventileinstellung
2509	Spezial-Ringschlüssel 10 x 14	2569	Spezienschlüssel für Rollenlenkung
2511	Führungsplatte	2570	Ventileinschleifer
2512	Hebelverlängerung	2572	Spezienschlüssel für Brennstoffhahn
	Gabelschlüssel, einseitig	2573	Spezienschlüssel für Ansaugrohr
2513-24a	gerade, 24 mm	2575/3	Kreuzschlitzschraubendreher (814-2, -3, -4)
b	gebogen, 24 mm	2576	Sprengringzange
2513-27a	gerade, 27 mm	2590	Drehmomentschlüssel
b	gebogen, 27 mm		
2513-32a	gerade, 32 mm		
b	gebogen, 32 mm		
2514	T-Griff-Schlüssel, 150 mm lang		
2514-1	dito, 300 mm lang		
2519	Führungsdorn		
2520-10	Ventil-Einstell-Lehre 0,10 mm		
2520-20	dito 0,20 mm		
2523-75	Kolbenring-Spannband 75 mm		
2523-77	dito 77 mm		
2523-83	dito 83 mm		
2500 T/68	68teilig	24	845.—



**Werkzeugsätze
CHROM-VANADIUM**

2500 P für Volkswagen

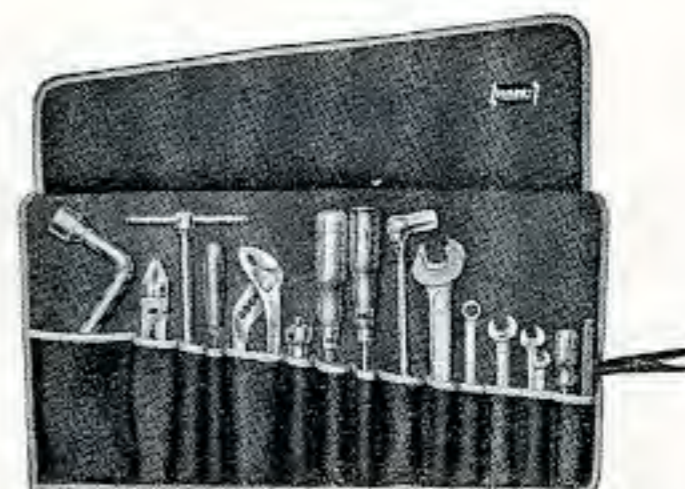

in Plastic-Tasche

Bestell-Nr.	Inhalt	Verchromt
2500 P / 13	13teilig für VW 1200	78.60
2500 P / 17	17teilig für VW 1500	114.80

INHALTSÜBERSICHT HAZET 2500 P/13			
450	Gabelschlüssel 8 x 9 10 x 14 17 x 19	811-6	Schraubendreher 125 x 7
600	Gabel-Ringschlüssel, lang, 14 x 14	813-3	dito 100 x 3,5
760-3	Universalzange 9 1/2"	1850-2	Kombizange 6 1/2"
764	Zündkerzenschlüssel	2125	Kontaktfeile
772	Radschraubenkurbel	2131	Zündkerzenbürste
		2561	Ringschlüssel 21 x 36

INHALTSÜBERSICHT HAZET 2500 P/17			
450	Gabelschlüssel 7 x 8 9 x 11 10 x 14	1850-2	Kombizange 6 1/2"
600	Gabel-Ringschlüssel, lang, 13 x 13	2125	Kontaktfeile
760-3	Universalzange 9 1/2"	2505	Spezial-Zündkerzenschlüssel
772	Radschraubenkurbel		Gabelschlüssel, einseitig
811-6	Schraubendreher 125 x 7	2513-24a	gerade, 24 mm
813-2	dito 80 x 3	b	gebogen, 24 mm
814-3	Kreuzschlitzschraubendreher für Phillips-Schrauben Nr. 12-16	2527-13	Steckschlüssel 13 mm
814-02	dito Nr. 5-10	2567	Spezienschlüssel für den Öldienst



**Werkzeugausrüstung
CHROM-VANADIUM**

2500WA für Volkswagen



im verschließbaren,
hausfarbenen
HAZET-Metallkasten

Kastengröße: 420 x 200 x 150 mm

Bestell-Nr.	Inhalt	Gewicht kg	Verchromt
450	Gabelschlüssel 8 x 9 10 x 14 17 x 19 22 x 27	2130	Drahtbürste
605	Gabel-Ringschlüssel, kurz, 13 x 13 15 x 15	2140-5	Hammer 500 g
615	Starter- und Blockschlüssel 11 x 13	2142	Leichtmetallhammer 500 g
630	Ringschlüssel, gekröpft, 17 x 19	2146	Fühlerlehre, 6 tlg.
730-3	Flachmeißel 150 x 18	2505	Spezial-Zündkerzenschlüssel
745-10	Durchschläger 120 x 2	2509	Spezial-Ringschlüssel 10 x 14
760-3	Universalzange 9 1/2"		Gabelschlüssel, einseitig
811-1	Schraubendreher 75 x 5	2513-27a	gerade, 27 mm
811-9	dito 150 x 8	b	gebogen, 27 mm
813-2	dito 80 x 3	2514	T-Griff-Schlüssel
900	Sechskanteinsätze 1/2" □ Antrieb 10 11 14 17	2527-13	Steckschlüssel 13 mm
915	T-Griff 12"	2527-14	dito 14 mm
919	T-Griff-Schlüssel	2559-24	Öldruckschalterschlüssel 24 mm
921	Innensechskant-Einsatz 8 mm	2560	Spezial-Ringschlüssel 27 x 36
1801-2	Seitenschneider 6 1/2"	2562	Steckschlüssel 27 x 30
1850-3	Kombizange 7"	2562 D	Dorn dazu, 12 mm ø
2122-5	Flachfeile 5"	2567	Spezienschlüssel für den Öldienst
2123-6	Dreikantfeile 6"	2572	Spezienschlüssel für Brennstoffhahn
		2575/3	Kreuzschlitzschraubendreher (814-2, -3, -4)
2500WA/45	45teilig	13	333.—



Spezialwerkzeuge

CHROM-VANADIUM

2500

insbesondere für Arbeiten an Volkswagen

Bestell-Nr.	mm	Verchromt
-------------	----	-----------

Ringschlüssel
doppelseitig gekröpft



630	17 x 19	6.60
-----	---------	------

Kolbenringzange



790 - 1	50 — 100	10.30
---------	----------	-------

Sechskant-Einsätze

1/2"



900 - 10	10	2.90
11	11	2.90
13	13	2.90
14	14	3.20
15	15	3.20
17	17	3.80
19	19	3.80
30	30	5.90

Schwungwinde

1/2"



911		9.80
-----	--	------

Schiebegriff

1/2"



915		7.50
-----	--	------

Verlängerungen

1/2"



917	125	3.80
918	250	5.—



Spezialwerkzeuge

CHROM-VANADIUM

2500

insbesondere für Arbeiten an Volkswagen

Bestell-Nr.	mm	Verchromt
-------------	----	-----------

T-Griff-Schlüssel

1/2"



919		10.90
-----	--	-------

Innensechskant-Einsätze

1/2"



921	8	5.40
922	10	5.70

Spezial-Zündkerzenschlüssel
für VW 1200 und VW 1500



2502	21	5.40
------	----	------

Spezial-Zündkerzenschlüssel
für VW 1500-Ghia

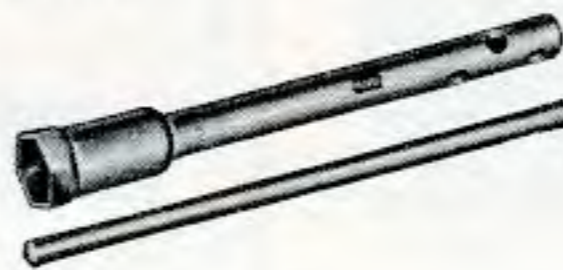

2503	21	7.60
------	----	------

Zündkerzenschlüssel

verstellbar (DBGM)
mit abgewinkeltem Dorn
für sämtliche VW-Typen

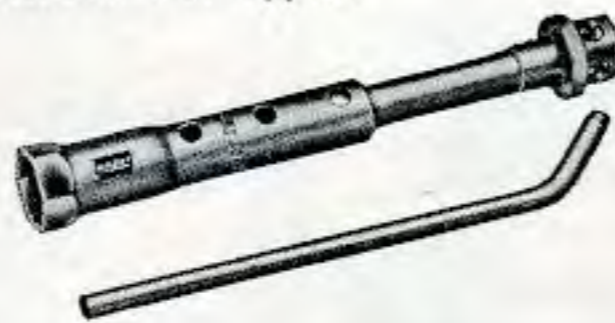

2505	21	11.90
------	----	-------

Dorn
für Kolbenbolzen



2507		13.90
------	--	-------

Spezial-Ringschlüssel
für Ölkühler und Vergaser



2509	10 x 14	10.20
------	---------	-------



Spezialwerkzeuge

CHROM-VANADIUM

2500

insbesondere für Arbeiten an Volkswagen

Bestell-Nr.	mm	Verchromt
-------------	----	-----------

Werkzeug für Schwungscheibe
und Hinterachse



2510	bestehend aus:		
	1015	Schiebegriff 500 mm	20.90
	1056	Einsatz 36 mm	9.70
	2511	Führungsplatte	9.50
	2512	Hebel- verlängerung	8.60

Einseitige Gabelschlüssel
gerade und gebogen

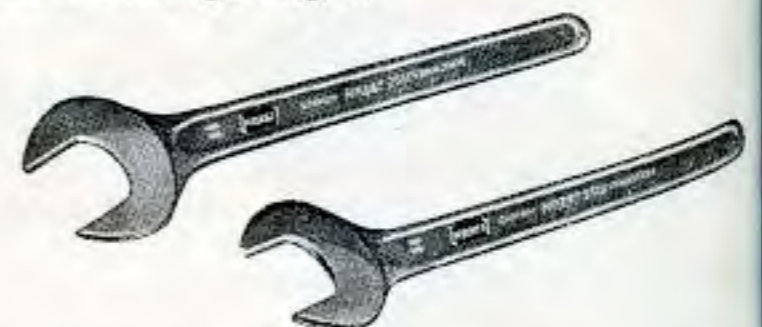

2513 - 24 a	24 mm, gerade	3.50
24 b	24 mm, gebogen	3.50
2513 - 27 a	27 mm, gerade	3.60
27 b	27 mm, gebogen	3.60
2513 - 32 a	32 mm, gerade	4.40
32 b	32 mm, gebogen	4.40

T-Griff-Schlüssel

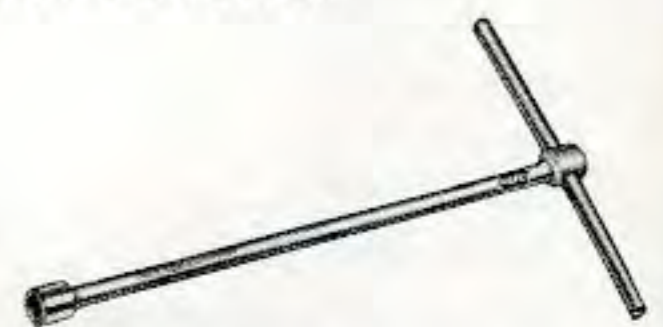

Bestell-Nr.	Innen-Vierkant mm	Länge mm	Verchromt
2514	8	150	9.50
2514 - 1	8	300	10.60

Führungsdorn
zum Zentrieren der Kupplungsscheibe



Bestell-Nr.	mm	Verchromt
2519		13.—

Ventileinstell-Lehren
mit 10 Reserveblättchen



2520 - 10	0,10	6.70
20	0,20	6.70
30	0,30	6.70



**Spezialwerkzeuge
CHROM-VANADIUM**

2500

insbesondere für
Arbeiten an Volkswagen

Bestell-Nr.	mm	Verchromt
-------------	----	-----------

Kolbenring-Spannbänder



2523 - 75	75 - 76	13.—
77	77 - 78	13.—
83	83	14.20

Kerbstemmer



2524		4.80
------	--	------

Sprengringzange

für Antriebswelle und Kurbelwelle



2525 K		35.40
--------	--	-------

Ersatzbacken dazu

2525 K - 1	per Paar	7.90
------------	----------	------

Steckschlüssel

mit Kugelgelenk



2527 - 13	13	17.40
14	14	17.40

Dorne



2530 a

2531

2533

Bestell-Nr.	für	Verchromt
2530 a	Achsschenkelbolzen 7,9 mm ø	13.90
2530 b	dto., 5,9 mm ø	13.90
2531	Achsschenkelbolzen- buchsen 17,5 mm ø	14.30
2531 a	dto., 21,5 mm ø	14.30
2533	Bundbolzenbuchsen 17,9 mm ø	14.30
2533 a	dto., 19,9 mm ø	16.—

Öldruckschalter-Schlüssel

mit Kugelgelenk



Bestell-Nr.	mm	Verchromt
2559 - 24	24	20.30
27	27	20.30



**Spezialwerkzeuge
CHROM-VANADIUM**

2500

insbesondere für
Arbeiten an Volkswagen

Bestell-Nr.	mm	Verchromt
-------------	----	-----------

Spezial-Ringschlüssel



2560	27 x 36	18.60
------	---------	-------

Ringschlüssel



21er Seite um 15° abgewinkelt

2561	21 x 36	13.—
------	---------	------

Steckschlüssel



2562	27 x 30	4.60
------	---------	------

Dorn dazu



2562 D	12 ø	1.60
--------	------	------

Spezienschlüssel

für Zylinderkopfmuttern



2565	15	12.40
------	----	-------

Spezienschlüssel

für Schalter des
Scheibenwischer-Motors



2566		5.70
------	--	------

Spezienschlüssel

für den Öldienst

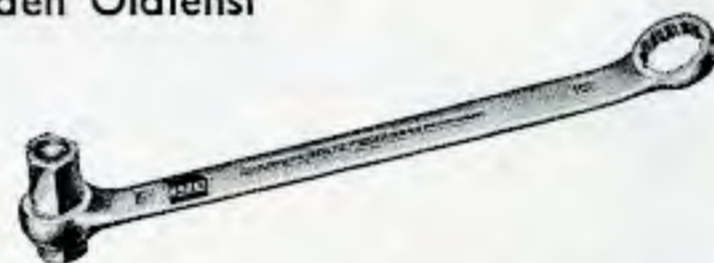

2567	17 x 21	13.20
------	---------	-------

Spezienschlüssel

für Ventileinstellung, DBGM
mit Schraubendreher, speziell für VW 1500



2568	13	19.70
------	----	-------



**Spezialwerkzeuge
CHROM-VANADIUM**

2500

insbesondere für
Arbeiten an Volkswagen

Bestell-Nr.	mm	Verchromt
-------------	----	-----------

Spezienschlüssel

für die Rollenlenkung, DBGM



für VW 1500
Ringschlüssel-Seite für VW 1200

2569	17 x 17	21.60
------	---------	-------

Ventileinschleifer

mit Saugnapf



Bestell-Nr.	Saugfläche	Preis
2570	25 mm ø	3.—

Spezienschlüssel

für Brennstoffhahn



Bestell-Nr.	mm	Verchromt
2572		6.50

Spezienschlüssel

für Befestigungsmutter am Ansaugrohr
für VW 1500



2573	10	11.90
------	----	-------

**Kreuzschlitz-Schraubendreher-
satz**



Bestell-Nr.	bestehend aus	Preis
2575 / 3	Nr. 814-2,-3,-4	18.70

Sprengringzange

für Kolbenbolzensicherungen



Bestell-Nr.	Verchromt
2576	11.90

Drehmomentschlüssel



bis 6 mkg
maximal

2590		97.20
------	--	-------



Spezialwerkzeuge CHROM-VANADIUM

2700

insbesondere für Arbeiten
an Mercedes-Fahrzeugen

Bestell-Nr.	mm	Verchromt
-------------	----	-----------

Ventileinstellschlüssel Maulstellung 0 und 30°



325	14 x 14	5.20
-----	---------	------

Spezialschlüssel für Ventileinstellung, mit Schraubendreher



327	14	40.20
-----	----	-------

Spezialschlüssel für Ventileinstellung, mit Schraubendreher, speziell für Unimog

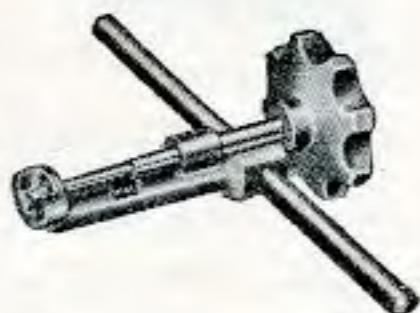

328	14	35.40
-----	----	-------

Gelenk-Zündkerzenschlüssel mit Gelenkspannfeder

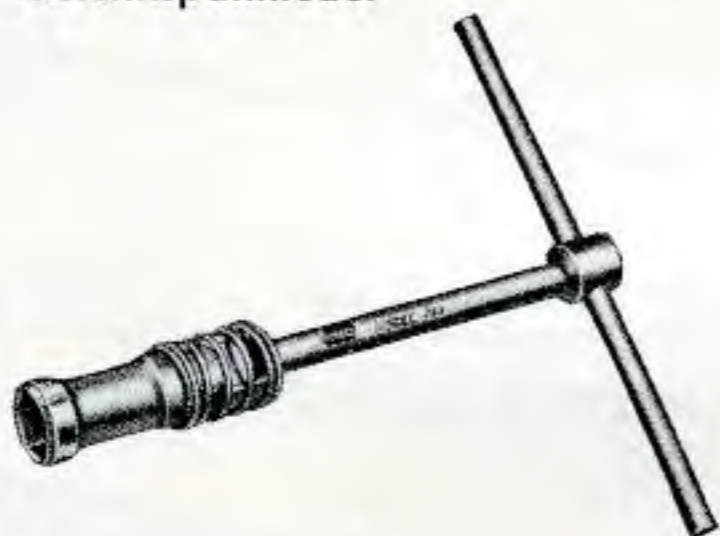

762	21	13.50
-----	----	-------

Gelenk-Zündkerzenschlüssel mit Kugelgelenk



767	21	8.60
-----	----	------

Zwölfkant-Einsätze extra tief

3/8



880 TZ - 14	14	4.60
17	17	5.50
19	19	5.90



Spezialwerkzeuge CHROM-VANADIUM

2700

insbesondere für Arbeiten
an Mercedes-Fahrzeugen

Bestell-Nr.	mm	Verchromt
-------------	----	-----------

Stecker für verschiedene Betätigungswerkzeuge



8813	8 ø	2.—
------	-----	-----

Schiebegriff

3/8



8815		6.40
------	--	------

Kardangelenk

3/8



8820		9.—
------	--	-----

Verlängerungen

3/8



Bestell-Nr.	Zoll	Verchromt
-------------	------	-----------

8821 - 3	3	5.—
6	6	5.50
8	8	6.40

Reduzier-Einsatz

3/8



958 R II	3/8" <input type="checkbox"/> massiv 1/2" <input type="checkbox"/> hohl	5.—
----------	--	-----

Spezial-Doppelgelenkschlüssel für Ölwanne

3/8



Bestell-Nr.	mm	Verchromt
-------------	----	-----------

2722	6	32.80
------	---	-------

Sechskant-Stiftschlüssel (Innensechskant-Schlüssel) nach DIN 911



Bestell-Nr.	mm	Glanzvernickelt
-------------	----	-----------------

2729	14	3.50
------	----	------



Spezialwerkzeuge CHROM-VANADIUM

2700

insbesondere für Arbeiten
an Mercedes-Fahrzeugen

Bestell-Nr.	mm	Verchromt
-------------	----	-----------

Spezial-Gelenkschlüssel für Innensechskantschrauben

3/8



2739	5	18.50
2740	6	19.40

Kurz-Gelenkschlüssel mit Zwölfkant

3/8



2742	14	27.30
------	----	-------

Spezialschlüssel für Register-Vergaser

3/8



2743	12	15.90
------	----	-------

Spezialschlüssel für Einspritzleitung

3/8



2745	17	16.40
------	----	-------

Innensechskant-Schlüssel

3/8



2747	5	7.80
2748	6	8.30
2749	8	7.70
2750	10	8.30

Spezialschlüssel für den Öldienst



2760	14 x 17	11.90
------	---------	-------



**Spezialwerkzeuge
CHROM-VANADIUM**

2800

insbesondere für Arbeiten
an Mercedes-Fahrzeugen

Bestell-Nr.	Inhalt	Verchromt
-------------	--------	-----------

Ratschen-Garnitur

3/8"

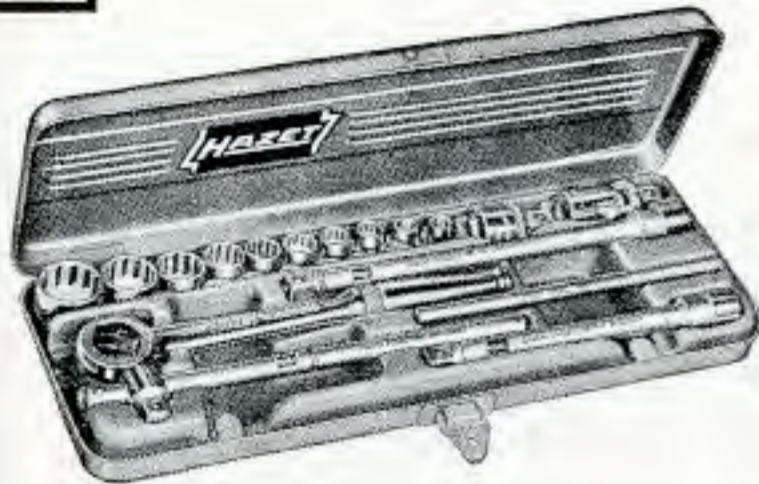

im hausfarbenen
HAZET-Metallkasten

- 880 Sechskanteinsätze
7 8
- 880 Z Zwölfkanteinsätze
9 10 11 12
14 17 19 22
- 8813 Stecker 8 mm ø
- 8815 Schiebegriff 8"
- 8816 Umschaltknarre 8"
- 8820 Kardangelen
- 8821-6 Verlängerung 6"
- 8821-8 Verlängerung 8"
- 958 R II Reduziereinsatz $\frac{3}{8}$ " massiv
 $\frac{1}{2}$ " hohl

2800	17teilig	106.70
-------------	-----------------	---------------

Monteur-Satz

3/8"

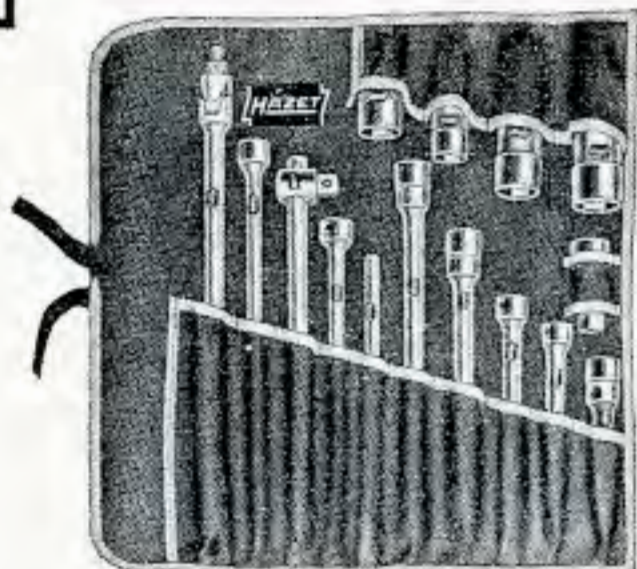

in Plastic-Tasche

- 880 TZ Zwölfkanteinsätze,
extra tief,
14 17 19
- 8813 Stecker 8 mm ø
- 8815 Schiebegriff 8"
- 8820 Kardangelen
- 8821-3 Verlängerung 3"
- 8821-6 Verlängerung 6"
- 8821-8 Verlängerung 8"
- 958 R II Reduziereinsatz $\frac{3}{8}$ " massiv
 $\frac{1}{2}$ " hohl
- 2739 Spezial-Gelenkschlüssel für
Innensechskantschrauben 5 mm
- 2747 Innensechskant-Schlüssel 5 mm
- 2748 Innensechskant-Schlüssel 6 mm
- 2749 Innensechskant-Schlüssel 8 mm
- 2750 Innensechskant-Schlüssel 10 mm

2804	15teilig	112.20
-------------	-----------------	---------------



**Spezialwerkzeuge
CHROM-VANADIUM**

2800

insbesondere für Arbeiten
an Mercedes-Fahrzeugen

Bestell-Nr.	Inhalt	Verchromt
-------------	--------	-----------

Monteur-Satz

3/8"

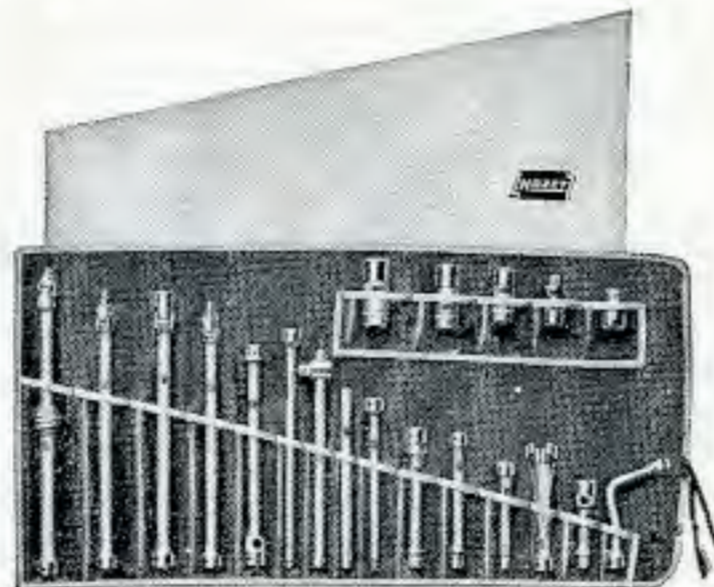

in Plastic-Tasche

- 880 TZ Zwölfkanteinsätze,
extra tief,
14 17 19
- 8813 Stecker 8 mm ø
- 8815 Schiebegriff 8"
- 8820 Kardangelen
- 8821-3 Verlängerung 3"
- 8821-6 Verlängerung 6"
- 8821-8 Verlängerung 8"
- 958 R II Reduziereinsatz $\frac{3}{8}$ " massiv
 $\frac{1}{2}$ " hohl
- 2722 Doppel-Gelenkschlüssel 6 mm
- 2739 Spezial-Gelenkschlüssel für
Innensechskantschrauben 5 mm
- 2740 Gelenkschlüssel 6 mm
- 2742 Gelenkschlüssel 14 mm
- 2743 Spezialschlüssel 12 kant, 12 mm
- 2745 Spezialschlüssel 12 kant, 17 mm
- 2747 Innensechskant-Schlüssel 5 mm
- 2748 Innensechskant-Schlüssel 6 mm
- 2749 Innensechskant-Schlüssel 8 mm
- 2750 Innensechskant-Schlüssel 10 mm

2805	20teilig	230.—
-------------	-----------------	--------------



**Spezialwerkzeuge
CHROM-VANADIUM**

2800

insbesondere für Arbeiten
an Mercedes-Fahrzeugen

Bestell-Nr.	Inhalt	Verchromt
-------------	--------	-----------

Zwergsatz

für Vergaser, Radio usw.

1/4"

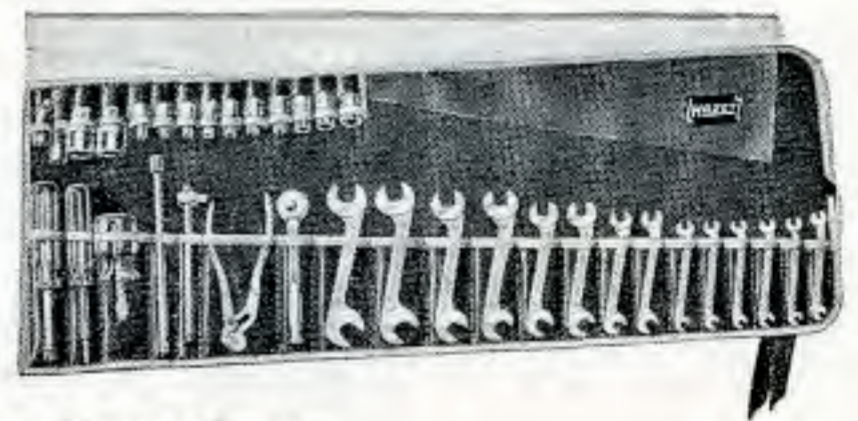

in Plastic-Tasche

- 330 Kleingabelschlüssel
3,5 x 4 4 x 3,5
4,5 x 5 5 x 4,5
5,5 x 6 6 x 5,5
7 x 8 8 x 7
9 x 10 10 x 9
11 x 12 12 x 11
13 x 14 14 x 13
- 760-1 Universalzange 4 1/2"
- 833-1 Elektrikerschraubendreher
60 x 2,5
- 834-2 Vergaserschraubendreher
25 x 6
- 850 Sechskanteinsätze
4 4,5 5 5,5 6
7 8 9 10 11
- 858 RI Reduziereinsatz $\frac{1}{4}$ " massiv
 $\frac{3}{8}$ " hohl
- 858 RII Reduziereinsatz $\frac{3}{8}$ " massiv
 $\frac{1}{4}$ " hohl
- 863 Umschaltknarre 4 1/2"
- 865 Schiebegriff 5"
- 866 Vierkantkebel 5"
- 867 Verlängerung 2"
- 868 Verlängerung 6"
- 869 Kardangelen

2806	35teilig	149.60
-------------	-----------------	---------------

An- und Abnehmersatz

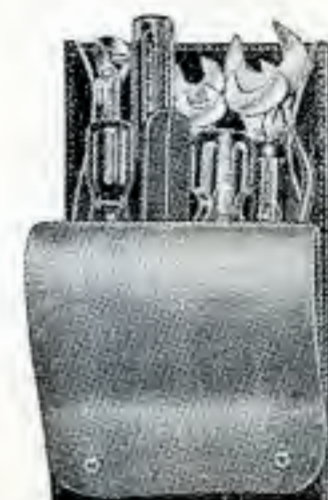

in Spallleder-Tasche

- 450 Gabelschlüssel
6 x 7 8 x 9 10 x 11
12 x 14 17 x 19
- 760-1 Universalzange 4 1/2"
- 814-02 Kreuzschlitzschraubendreher
für Phillips-Schrauben Nr. 5-10
- 834-2 Vergaserschraubendreher 25 x 6
- 837-2 Zündkerzenprüfer 100 x 5
Schlauchbandstift
Kerzenlehre Bosch EFK
Spezialtaschenlampe

2807	12teilig	59.20
-------------	-----------------	--------------



Übersicht

der Einsatzmöglichkeiten von VOLKSWAGEN-Spezial- und Normal-Werkzeugen

Motor und Kupplung = M Kraftstoffanlage = K Vorderachse und Lenkung = V Hinterachse und Getriebe = H Bremsen und Räder = B Elektrische Anlage = E Schmierung und Wartung = S Rahmen = R Aufbau = A	VW 1200									Transporter									VW 1500								
	M	K	V	H	B	E	S	R	A	M	K	V	H	B	E	S	R	A	M	K	V	H	B	E	S	R	A
HAZET 450 - 6 x 7	●		●		●	●	●			●				●	●	●			●		●		●	●	●		
8 x 9	●	●				●	●			●	●	●				●			●	●				●	●		●
10 x 11	●	●	●		●	●	●	●		●	●	●		●	●	●	●	●	●	●	●		●	●	●	●	●
12 x 13	●	●				●	●	●	●	●	●	●			●	●	●	●	●	●	●		●	●	●	●	●
14 x 15	●	●		●		●	●	●	●	●	●	●	●		●	●	●	●	●			●		●	●	●	●
17 x 19	●	●		●		●	●	●	●	●	●	●	●		●	●	●	●	●	●		●		●	●	●	●
22 x 27	●	●					●			●	●	●		●		●			●	●				●	●		●
615 - 11 x 13		●									●									●							
630 - 6 x 7							●									●									●		
8 x 9						●						●												●			●
10 x 11	●									●		●			●				●					●			●
13 x 15	●	●		●		●		●		●	●	●	●		●		●		●	●		●		●		●	●
14 x 17	●	●	●	●	●	●	●	●	●	●	●	●	●	●	●	●	●	●	●		●	●	●	●	●	●	●
19 x 22	●		●	●	●		●			●		●	●	●		●			●		●	●	●		●		
21 x 23							●									●									●		
24 x 27	●									●					●				●								
27 x 30	●			●			●			●			●		●				●			●		●			●
32 x 36				●									●									●					
764	●					●	●			●					●	●			●								
790 - 1	●									●									●								
796					●									●									●				
798	●						●			●						●			●								
811 - 1	●	●								●	●				●				●	●				●			●
3	●	●	●	●	●	●	●	●	●	●	●	●	●	●	●	●	●	●	●	●	●	●	●	●	●	●	●
9	●	●		●			●	●	●	●	●		●			●	●	●	●	●				●	●	●	●
813 - 2						●	●								●	●								●	●		
814 - 0						●									●												
2								●									●							●	●		●
4								●									●								●		●
818 - 2																											●
819 - 1																								●			●
834 - 3		●					●				●					●				●					●		
837 - 1 α	●					●	●			●					●	●			●					●	●		
900 - 10				●			●						●		●	●						●		●	●		●
11				●									●									●					
13	●			●				●	●	●			●	●	●			●			●		●			●	
14	●			●			●	●		●			●					●			●				●	●	
15				●									●	●							●						
17	●		●	●	●		●	●		●		●	●	●				●		●	●	●		●		●	
19	●		●	●	●					●		●	●	●				●		●	●	●					
24													●														
27						●							●												●		
32				●									●									●					
911	●		●	●	●	●	●		●	●		●	●	●	●	●		●	●		●	●	●	●	●	●	●
915	●		●	●						●		●	●						●		●	●					●
916	●		●	●	●	●	●		●	●		●	●	●	●	●		●	●		●	●	●	●	●	●	●
917	●		●	●	●	●	●		●	●		●	●	●	●	●		●	●		●	●	●	●	●	●	●
918	●		●	●	●	●	●		●	●		●	●	●	●	●		●	●		●	●	●	●	●	●	●
919	●						●			●						●			●						●		●
921	●		●							●		●															
922	●									●																	
985 - 6																								●			●
990 - 6	●																										

Übersicht

der Einsatzmöglichkeiten von VOLKSWAGEN-Spezial- und Normal-Werkzeugen



	VW 1200									Transporter									VW 1500								
	M	K	V	H	B	E	S	R	A	M	K	V	H	B	E	S	R	A	M	K	V	H	B	E	S	R	A
1000 - 41													•														
46													•														
1015	•			•		•				•			•		•				•			•					
1056	•			•		•				•			•		•				•			•					
1846 a - 2				•									•														
d - 2				•									•														
2100 - 3																											•
8													•														
2125						•									•												
2146	•			•		•	•			•			•		•	•			•			•	•				
2152						•									•								•	•			
2502	•					•	•																•	•			
2503																							•	•			
2505	•					•	•			•					•	•							•	•			
2507	•									•																	
2509	•	•						•																			
2510	•			•		•				•			•		•				•			•					
2511	•			•		•				•			•		•				•			•					
2512	•			•		•				•			•		•				•			•					
2513 - 24 a																						•	•		•		
24 b																						•	•		•		
27 a				•		•		•					•		•		•		•			•		•			
27 b				•		•		•					•		•		•		•			•		•			
32 a															•							•		•			
32 b															•							•		•			
2514	•			•						•			•														
2514 - 1																						•		•			
2519	•									•												•					
2520 - 10	•							•																			
20	•							•																			
30	•							•																			
2523 - 75	•									•																	
77	•									•																	
83										•												•					
2524	•									•												•					
2525 K	•					•				•					•												
2527 - 13			•					•			•					•				•					•		
14			•					•			•					•				•							
2530 a				•																							
2530 b				•																							
2531				•																							
2531 a												•															
2533				•																							
2533 a												•															
2559 - 24	•					•				•					•				•				•				
27	•					•				•					•				•								
2560	•			•				•		•			•														
2561	•							•		•																	
2562	•			•	•																						
2562 D	•			•	•																						
2565	•									•												•					
2566						•																					
2567	•			•				•		•			•														
2568										•												•					
2569				•				•				•										•				•	
2570	•									•												•					
2572			•									•															
2573																						•					
2575/3						•			•						•			•				•		•			•
2576	•								•	•												•					
2590	•		•		•				•	•		•		•							•	•		•			•

Gegenüberstellung

deutscher, amerikanischer, englischer, norwegischer, französischer und schwedischer Maße für Schraubenschlüssel – grau unterlegte Maße sind Bestellmaße

Maulweite Nennmaß mm	Metrische Maße								Amerikanische Maße						Englische Maße						
	Gewinde-Durchmesser								Maulweiten		Gewinde-Durchmesser						Schlüssel- weite		BSW großer 6 kant BS 192	BSF u. BSW kleiner 6 kant BS 1083	BA
	Deutsche Maße DIN		Norwegisch Metrisch	Französisch Metrisch	Schwedisch SMS						Schrauben und Muttern nach SAE	USS		Americ. Stand.		mm					
Me- trisch	Whit- worth	klein 1427			groß 1425	klein 1428	groß 1426	Schrauben und Muttern	Kopf- schrauben	Schrauben und Muttern		Kopf- schrauben									
3																2,97	.117			10	
3,5	1,7															3,33	.131			9	
4	2		1,7		2,3			3,97	5/32					0, 1		3,86	.152			8	
4,5	2,3				2,6			4,76	3/16					2, 3		4,37	.172			7	
5	2,6		2,3	3	3											4,90	.193			6	
								5,20	13/64												
5,5	3							5,56	7/32							5,59	.220			5	
								5,99	15/64							6,30	.248			4	
6	3,5	1/8	3	3,5	3,5	3		6,35	1/4					4		6,50	.256	1/16	3/32		
								6,75	17/64												
7	4		3,5	4	4	3,5		7,14	9/32							7,16	.282			3	
			4,5					7,50	19/64							7,54	.297	3/32	1/8		
8			4	5	5	4		7,94	5/16		1/8	1/8	5, 6		8,23	.324			2		
								8,64							8,64	.340	1/8	3/16			
9	5	3/16	5	5,5	5			8,73	11/32				8		9,27	.365			1		
10	6		5,5	6	6			9,52	3/8			3/16	10		10,49	.412			0		
								10,32	13/32												
11	7	1/4	6,7		7	6	1/4	11,11	7/16	1/4		1/4	12,1/4	1/4	11,30	.445	3/16	1/4			
12				7	8			12,70	1/2	5/16	1/4	5/16		5/16							
13							5/16	1/4							13,33	.525	1/4	5/16			
14	8	5/16	8	8	8			14,29	9/16	3/8		3/8	5/16	3/8							
15					10		3/8	5/16	15,08	19/32		5/16			15,24	.600	5/16	3/8			
16				9				15,88	5/8	7/16		7/16	3/8	7/16							
17	10	3/8	9	10	10			17,46	11/16			3/8									
18					12		7/16	3/8							18,03	.710	3/8	7/16			
19	12	7/16	11	11				19,05	3/4	1/2		1/2	7/16	1/2							
20	Zünd- kerzen M 14							19,84	25/32			7/16			20,83	.820	7/16	1/2			
20,5								20,64	13/16			9/16	1/2	9/16							
21				12	14		1/2	7/16													
22	14	1/2	12	14		12		22,22	7/8	9/16	1/2	5/8	9/16	5/8							
23				14			1/2	23,81	15/16	5/8					23,34	.920	1/2	9/16			
24	16				16		5/8	24,61	31/32			9/16									
25								25,40	1	11/16		3/4	5/8	3/4	25,65	1.010	9/16	5/8			
26	Zünd- kerzen M 18			16																	
27	18	5/8	16		18	16		26,99	11/16	3/4	5/8										
28							3/4	5/8	28,57	11/8			7/8	3/4	7/8	27,94	1.100	5/8	11/16		
29				18																	
30	20				20			30,15	1 3/16						30,48	1.200	11/16	3/4			
32	22	3/4	18	20	20	22	18	20	31,75	1 1/4	7/8	3/4	1								

Gegenüberstellung

deutscher, amerikanischer, englischer, norwegischer, französischer und schwedischer Maße für Schraubenschlüssel – grau unterlegte Maße sind Bestellmaße

Maulweite Nennmaß mm	Metrische Maße								Amerikanische Maße						Englische Maße					
	Gewinde-Durchmesser								Maulweiten mm Zoll		Gewinde-Durchmesser				Schlüssel- weite mm Zoll		BSW großer 6 kant BS 192	BSF u. BSW kleiner 6 kant BS 1083	BA	
	Deutsche Maße DIN		Norwegisch Metrisch	Französisch Metrisch	Schwedisch SMS		Schrauben und Muttern nach SAE	USS			Americ. Stand.									
Me- trisch	Whit- worth	klein 1427			groß 1425	klein 1428		groß 1426	Schrauben und Muttern	Kopf- schrauben	Schrauben und Muttern	Kopf- schrauben								
33						7/8	3/4	33,34	1 5/16					7/8	1	33,02	1.300	3/4	7/8	
35				22				34,92	1 3/8				1 1/8			35,31	1.390	13/16	15/16	
36	24	7/8	22 24		22 24			36,51	1 7/16	1	7/8									
37						1	7/8									37,59	1.480	7/8	1	
38				24				38,10	1 1/2			1 1/4	1	1 1/8						
41	27	1	27		27			41,28	1 5/8	1 1/8	1	1 3/8			40,13	1.580	15/16	1 1/16		
42				27		1 1/8	1	42,86	1 11/16					1 1/8	1 1/4	42,42	1.670	1	1 1/8	
								44,45	1 3/4											
46	30	1 1/8	30	30	30			46,04	1 13/16	1 1/4	1 1/8									
47						1 1/4	1 1/8	47,62	1 7/8					1 1/4		47,24	1.860	1 1/8	1 1/4	
50	33	1 1/4	33	33	33			50,80	2	1 3/8	1 1/4									
52						1 3/8	1 1/4	52,39	2 1/16					1 3/8		52,07	2.050	1 1/4	1 3/8	
54				36																
55	36	1 3/8	36		36			55,56	2 3/16	1 1/2	1 3/8									
56						1 1/2	1 3/8	57,15	2 1/4					1 1/2		56,39	2.220	1 3/8	1 1/2	
58				39																
60	39	1 1/2	39		39	1 5/8	1 1/2	60,32 61,91	2 3/8 2 7/16		1 1/2			1 5/8		61,21	2.410	1 1/2	1 5/8	
63				42																
65	42	1 5/8	42		42	1 3/4	1 5/8	65,09	2 9/16		1 5/8					65,53	2.580	1 5/8	1 3/4	
67				45				66,68	2 5/8					1 3/4						
70	45	1 3/4	45		45	1 7/8	1 3/4	69,85	2 3/4		1 3/4					70,10	2.760	1 3/4	2	
71				48				71,44	2 13/16					1 7/8						
75	48	1 7/8	48		48	2	1 7/8	74,61	2 15/16		1 7/8									
77				52				76,20	3					2						
80	52	2	52		52		2	79,38	3 1/8		2					80,01	3.150	2	2 1/4	
82				56																
85	56	2 1/4	56		56		2 1/4	85,72	3 3/8					2 1/4						
88				60				88,90	3 1/2		2 1/4									
90	60		60		60											90,17	3.550	2 1/4	2 1/2	
94				64																
95	64	2 1/2	64		64		2 1/2	95,25	3 3/4					2 1/2						
100	68		68	68	68			98,42	3 7/8		2 1/2					98,81	3.890	2 1/2	2 3/4	
105	72	2 3/4	72	72	72		2 3/4	104,78	4 1/8					2 3/4		106,17	4.180	2 3/4	3	
110	76	3	76	76	76		3	107,95	4 1/4		2 3/4									
115	80		80		80			114,30	4 1/2					3		115,06	4.530	3	3 1/4	
116				80				117,48	4 5/8		3									
120	85	3 1/4	84		85		3 1/4									123,19	4.850	3 1/4	3 1/2	
130	90	3 1/2	89		90		3 1/2	127,00	5		3 1/4					131,57	5.180	3 1/2	3 3/4	
135	95	3 3/4	94		95		3 3/4	136,52	5 3/8		3 1/2									
145	100	4	99		100		4	146,05	5 3/4		3 3/4					140,92	5.550	3 3/4	4	
150	105		104		105															
155	110	4 1/4	109		110		4 1/4	155,57	6 1/8		4									

	Seite		Seite		Seite
A	Abzieher	23	K	Kabelmesser	48
	Abisolierzangen	44		Kardangelenke	32, 34, 37, 39
	Achtkant-Einsätze	32		Karosserie-Werkzeuge	45-46
	Assistent	7-8, 52		Klebschlag-Hammer	46
	Aufsatzschrank	4-5		Kleingabelschlüssel	12
	Aufsteckrohre für Ringschlüssel	19		Kleinrohrabschneider	48
	Ausbeulwerkzeuge	45-46		Knarrenschlüssel	32, 34, 37, 39
	Ausstellungsschränke	47		Körner	20, 21
B	Batterie-Werkzeuge	25, 44		Kolbenringwerkzeuge	24, 54, 55
	Befähigungswerkzeuge für			Kombinationsstücke	49-50
	Einsätze	32, 34, 37, 39		Kombinationszangen	44
	Bits	49-50		Kreuzmeißel	20, 21
	Blechscher	44		Kreuzschlitzschraubendreher	28, 29
	Blockschlüssel	16		Kreuzschlitzschraubendreher-	
	Bördelgerät	48		Einsätze	34, 49-51
	Bremsfederzangen	24		Kreuzschlüssel	20
D	Dekorations- und Verkaufs-		L	Langbeckzangen	43
	ständer	11, 14, 16, 17, 18, 21, 22		Leichtmetallhammer	48
	Doppelmutter	11-14		Lenkradabzieher	23
	Drahtbürste	48		Long-Grip-Zangen	44
	Drehmomentschlüssel	55	M	Magazinhalter für Schraubendreher-	
	Drehstifte	12		Einsätze	50
	Dreikantschaber	28		Magnetschlüssel	11
	Durchschläger	20, 21		Magnetsucher	46
E	Einsätze	32-39, 49-51		Maulschlüssel	11-14
	Einsatzkästen	32-39		Meißel	20, 21
	Einschleifer für Ventile	24		Mercedes-Spezialwerkzeuge	56-57
	Elektriker-Schraubendreher	28, 29		Metallsägebogen	46
	Elektro-, Preßluftschrauber-			Monteursätze (Volkswagen- und	
	Einsatzprogramm	49-50		Mercedes-Spezialwerkzeuge) 52, 53, 57	
	Englische Hämmer	48		Montiereisen	20
	Ersatzrad-Kappe mit		O	Opel-Spezialwerkzeuge	16, 30, 37, 47
	Werkzeug für VW	52		Oldienstschlüssel	16, 55, 56
F	Feilen	48		Öldruckschalterschlüssel	55
	Figurenschere	44		Ölkännchen	48
	Flachmeißel	20, 21	P	Plastic-Hämmer	46
	Flachzangen	43		Polklemmenabzieher	25
	Fordson-Traktorentasche	39		Polklemmenreinigungsbürste	25
	Fühlerblattlehren	48		Polklemmenzange	25
G	Gabelschlüssel	11-14		Preßluft-, Elektroschrauber-	
	Gabel-Ringschlüssel	14-15		Einsatzprogramm	49-50
	Gegenstützvorrichtung	23		Prüflampe	48
	Gelenkschlüssel	19, 20	R	Radabzieher	23
	Gewindefeilen	48		Radmutternschlüssel	20, 22
	Grip-Zangen	21		Reduziereinsätze	32, 37, 39
	Gummihämmer	46, 48		Reifenheber	20
H	Hämmer	46, 48		Reißnadel	48
	Halter für Schraubendreher-			Reklame- und Verkaufs-	
	Einsätze	50-51		ständer	11, 14, 16, 17, 18, 22
	HANDBOHRMASCHINE	48		Ringschlüssel	16-19
	HAZET-Assistent	7-8, 52		Rohrabschneider	48
	HAZET-Tourist	52		Rollbandmaß	48
	Hebeleisen	48		Rollgabelschlüssel	11
	Hebelseiten- und Vorschneider	43		Rundzangen	43
	Herrenfahrer-		S	Sägebogen	46
	Werkzeugtaschen	27, 53		Säureprüfer	25
	Hohlschaber	28		Sechskant-Einsätze	32-38
I	Innenauszieher	23		Sechskant-Einsatzkästen	32-38
	Innensechskant-Einsätze 34, 37, 49-51			Sechskant-Steckschlüssel	12
	Innensechskant-Stiftschlüssel	47		Sechskant-Stiftschlüssel	47
	Isolierte Schraubendreher	29-30		Seitenschneider	43
	Isolierte Zangen	22, 43-44		Spennbänder für Kolbenringe	24, 55
				Spezialschlüssel für Oldienst 16, 55, 56	
				Spezialwerkzeuge für	
				Mercedes-Wagen	56-57
				Opel-Wagen	16, 30
				Volkswagen	52-55
				Spezialzangen für	
				Seegersicherungen	44
				Splintenausziehange	44
				Splintentreiber	20, 21
Sch	Schaber	28	St	Starter- und Blockschlüssel	16
	Schlagschraubendreher	51		Steckschlüssel	12
	Schlauchklemmenzangen	25		Steckschlüssel-Einsätze	32-39
	Schlosserhammer	48		Steckschlüssel-Einsatzkästen	32-39
	Schnellspann-Universalzange	22		Stehbolzenauszieher	30
	Schränke (verschiedene			Stiftschlüssel für Innensechskant	47
	Ausführungen)	2-5, 47		Stiftschlüssel, Vielzahn	47
	Schraubenausdreher	30	T	Taschen für Herrenfahrer	27, 53
	Schraubendreher-Einsätze	34, 49-51		Taschen für Motorradfahrer	27
	Schraubendreher-Einsatz-Halter	50		Taschen für Volkswagen- und	
	Schraubendreher	28-30		Mercedes-Werkzeugsätze	53, 57
	Schrauber-Einsatzprogramm	49-51		Tourist-Radkappe	52
	Schweißer-Grip-Zange	21		Traktorensätze	39
	Schwere Ringschlüssel	19		Türfederzange	25
St	Starter- und Blockschlüssel	16	T	Taschen für Herrenfahrer	27, 53
	Steckschlüssel	12		Taschen für Motorradfahrer	27
	Steckschlüssel-Einsätze	32-39		Taschen für Volkswagen- und	
	Steckschlüssel-Einsatzkästen	32-39		Mercedes-Werkzeugsätze	53, 57
	Stehbolzenauszieher	30		Tourist-Radkappe	52
	Stiftschlüssel für Innensechskant	47		Traktorensätze	39
	Stiftschlüssel, Vielzahn	47		Türfederzange	25
T	Taschen für Herrenfahrer	27, 53	U	Umschaltknarren	32, 34, 37, 39
	Taschen für Motorradfahrer	27		Universal-Figurenschere	44
	Taschen für Volkswagen- und			Universal-Figurschere	21
	Mercedes-Werkzeugsätze	53, 57		Universal-Radabzieher	23
	Tourist-Radkappe	52		Universal-Zangen	22
	Traktorensätze	39	V	Ventileinschleifer	24
	Türfederzange	25		Ventileinstellschlüssel	11, 55, 56
U	Umschaltknarren	32, 34, 37, 39		Ventileinstellschraubendreher 11, 30, 56	
	Universal-Figurenschere	44		Ventilfederhebezange	24
	Universal-Figurschere	21		Ventilfederspannapparat	24
	Universal-Radabzieher	23		Ventilkeilpistole	24
	Universal-Zangen	22		Verbindungsstücke für Schrauben-	
				dreher-Einsätze	49, 50, 51
				Verkaufsschränke	47
				Verkaufsständer und Verkaufs-	
				tafeln	11, 12, 14-22, 44, 45, 53
				Verstellbare Schlüssel	11
				Vielzahn-Einsätze	37
				Vielzahnschlüssel	47
				Volkswagen-Ersatzradkappe	
				mit Werkzeug	52
				Volkswagen-Spezialwerkzeuge	52-55
				Volkswagen-Werkzeugwagen,	
				-Kästen, -Tafeln und -Taschen	52-53
				Vorschneider	43
W	Wasserpumpenzangen	22	W	Wasserpumpenzangen	22
	Werbe- und Verkauf-			Werbe- und Verkauf-	
	ständer	11, 14, 16, 17, 18, 21, 22		ständer	11, 14, 16, 17, 18, 21, 22
	Werkbank	4-5		Werkbank	4-5
	Werkzeug-			Werkbank	4-5
	Ausrüstungen	25-26, 39, 53		Werkbank	4-5
	Werkzeug-Kästen 5-6, 25-26, 39-40, 45, 53			Werkbank	4-5
	Werkzeug-Koffer	5-6		Werkbank	4-5
	Werkzeugsätze	27, 40, 45, 52, 53, 57		Werkbank	4-5
	Werkzeug-Schränke	2-5, 47		Werkbank	4-5
	Werkzeugwagen			Werkbank	4-5
	HAZET-Assistent	7-8, 52		Werkbank	4-5
	Winkelschraubendreher	28		Werkbank	4-5
Z	Zangen	21-22, 24, 25, 43-44	Z	Zellenprüfer	25
	Zellenprüfer	25		Zündkerzenbürste	48
	Zündkerzenbürste	48		Zündkerzenprüfer	30
	Zündkerzenprüfer	30		Zündkerzenschlüssel	22, 54
	Zündkerzenschlüssel	22, 54		Zwölfkant-Einsätze	32-39
	Zwölfkant-Einsätze	32-39		Zwölfkant-Einsatzkästen	32-39
	Zwölfkant-Einsatzkästen	32-39		Zwölfkant-Gelenkschlüssel	19, 20
	Zwölfkant-Gelenkschlüssel	19, 20			

Alle Rechte an Text, Bild und Aufmachung vorbehalten. HAZET arbeitet stets an der Verbesserung seiner Erzeugnisse, deshalb können Abbildungen bzw. Angaben nicht immer der letzten Ausführung entsprechen und sind daher unverbindlich. Angegebene Gewichte wurden als Durchschnittswerte ermittelt und sind ebenfalls unverbindlich.

The history of the world is a long and varied one, filled with many interesting events and people. It is a story that has been told for thousands of years, and it continues to be told today. The history of the world is a story of progress, of discovery, and of the human spirit. It is a story that has shaped the world we live in today, and it will continue to shape the world of the future.

HAZET

